

DIGITAL DRIVE[®] SMS[™]-1

SUBWOOFER
MANAGEMENT
SYSTEM

**USER'S
MANUAL**



Featuring Software Version 2.1

Velodyne[®]

CAUTION!



Caution

To reduce the risk of electric shock, do not remove cover (or back). No user-serviceable parts inside. Refer servicing to qualified service personnel.

The lightning flash with arrowhead symbol is intended to alert the user to the presence of uninsulated “dangerous voltage” within the product’s enclosure that may be of sufficient magnitude to constitute a risk of electric shock to persons.

The exclamation point symbol is intended to alert the user to the presence of important operating and maintenance (servicing) instructions in the literature accompanying the subwoofer.

1. Read Instructions — All safety and operating instructions should be read before the subwoofer is operated.
2. Retain Instructions — The safety and operating instructions should be retained for future reference.
3. Heed Warnings — All warnings on the subwoofer and in the operating instructions should be adhered to.
4. Follow Instructions — All operating and use instructions should be followed.
5. Water and Moisture — The subwoofer should not be used near water — for example, near a bathtub, washbowl, kitchen sink, laundry tub, in a wet basement, near a swimming pool or the like.
6. Carts and Stands — The subwoofer should be used only with a cart or stand recommended by the manufacturer.
7. Wall or Ceiling Mounting — The subwoofer should be mounted to a wall or ceiling only as recommended by the manufacturer.
8. Ventilation — The subwoofer should be situated so that its location or position does not interfere with its proper ventilation. For example, the subwoofer should not be situated on a bed, sofa, rug, or similar surface that may block the ventilation openings; or placed in a built-in installation such as a bookcase or cabinet that may impede the flow of air through the ventilation openings.
9. Heat — The subwoofer should be situated away from heat sources such as radiators, heat registers, stoves, or other subwoofers that produce heat.
10. Power Sources — The subwoofer should be connected to a power supply only of the type described in the operating instructions or as marked on the subwoofer.
11. Power-Cord Protection — Power-supply cords should be routed so that they are not likely to be walked on or pinched by items placed upon or against them, paying particular attention to cords at plugs, convenience receptacles, and the point at which they exit from the subwoofer.
12. “Caution: To prevent electrical shock, match wide blade of plug to wide slot, fully inserted.”
13. Cleaning — The subwoofer should be cleaned only as recommended by the manufacturer.
14. Nonuse Periods — The power cord of the subwoofer should be unplugged from the outlet when left unused for a long period of time.
15. Object and Liquid Entry — Care should be taken so that objects do not fall and liquids are not spilled onto the enclosure.
16. Damage Requiring Service — The subwoofer should be serviced by qualified service personnel when:
 - a. The power-supply cord or plug has been damaged.
 - b. Objects have fallen or liquid has been spilled into the subwoofer.
 - c. The subwoofer has been exposed to rain.
 - d. The subwoofer does not appear to operate normally or exhibits a marked change in performance.
 - e. The subwoofer has been dropped or damaged.
17. Servicing — The user should not attempt to service the subwoofer beyond what is described in the operating instructions.
18. The apparatus shall not be exposed to dripping or splashing water and that no objects filled with liquids, such as vases be placed on the apparatus.
19. The disconnect device (the appliance inlet) shall remain readily operable (easily assessable).

All other servicing should be referred to qualified service personnel.

ATTENTION!



Attention

Afin d'éviter tout risque d'électrocution, ne pas enlever le couvercle (ou la partie arrière). Aucune pièce interne ne peut être manipulée par l'utilisateur. Confiez l'entretien à un personnel qualifié.

Le symbole de l'éclair avec la flèche sert à avertir l'utilisateur de la présence d'une « tension dangereuse » non isolée dans l'enceinte du produit; cette tension peut être assez élevée pour provoquer un danger d'électrocution pour les personnes.

Le symbole du point d'exclamation sert à avertir l'utilisateur de la présence de consignes importantes de fonctionnement et de maintenance (entretien) dans la documentation accompagnant le caisson d'extrêmes graves.

1. Lire les consignes — Lisez toutes les consignes de sécurité et de fonctionnement avant de faire fonctionner le caisson d'extrêmes graves.
2. Conserver les consignes – Conservez les consignes de fonctionnement pour un usage éventuel.
3. Tenir compte des avertissements – Il faut se conformer à tous les avertissements et à toutes les consignes de fonctionnement qui se trouvent sur le caisson d'extrêmes graves.
4. Suivre les consignes – Il faut se conformer à toutes les consignes de fonctionnement et d'utilisation.
5. Eau et humidité – Le caisson d'extrêmes graves ne doit pas être utilisé près de l'eau (par exemple, près d'un bain, d'un évier, d'un bac de lessive, dans un sous-sol humide, près d'une piscine, etc.).
6. Chariots et supports – Utiliser uniquement le caisson d'extrêmes graves avec un chariot ou un support recommandé par le fabricant.
7. Montage au mur ou au plafond – Monter uniquement le caisson d'extrêmes graves sur un mur ou un plafond de la façon recommandée par le fabricant.
8. Ventilation – Le caisson d'extrêmes graves doit être situé dans un endroit ou une position qui ne nuit pas à sa ventilation adéquate. Par exemple, ne pas placer le caisson sur un lit, un canapé, une moquette ou une surface semblable qui peut bloquer les ouvertures de ventilation; ne pas poser le caisson sur un meuble encastré comme une bibliothèque ou un meuble qui peut empêcher l'air de circuler par les ouvertures de ventilation.
9. Chaleur – Éloigner le caisson d'extrêmes graves des sources de chaleur comme les radiateurs, les registres d'air chaud, les cuisinières ou d'autres caissons d'extrêmes graves qui dégagent de la chaleur.
10. Sources d'électricité – Le caisson d'extrêmes graves doit être raccordé uniquement à une prise d'alimentation d'un type décrit dans les consignes de fonctionnement ou tel que mentionné sur le caisson.
11. Protection du cordon d'alimentation – Les cordons d'alimentation doivent être acheminés pour éviter que personne ne marche dessus ou que rien ne puisse être placé sur ou contre eux; il faut faire particulièrement attention aux cordons raccordés à des prises électriques, des prises de service et au point de sortie du caisson.
12. « Attention : Afin d'éviter tout choc électrique, introduire à fond la lame la plus large de la fiche dans la borne correspondante ».
13. Nettoyage – L'enceinte doit être nettoyée selon les recommandations du fabricant.
14. Périodes de non-utilisation – Le cordon d'alimentation de l'enceinte doit être débranché de la prise de courant lorsqu'elle demeure inutilisée pendant une période prolongée.
15. Infiltration d'objet ou de liquide – Faire attention à ce qu'aucun objet ne tombe dans l'enceinte ou que des liquides ne s'y infiltrent.
16. Dommages nécessitant réparation – L'enceinte doit être réparée uniquement par du personnel d'entretien qualifié lorsque :
 - a. le cordon d'alimentation ou la fiche a été endommagée;
 - b. des objets sont tombés dans l'enceinte ou du liquide s'y est infiltré;
 - c. l'enceinte a été exposée à la pluie;
 - d. l'enceinte ne semble pas fonctionner normalement ou présente un important changement de performance;
 - e. l'enceinte a été échappée ou endommagée.
17. Entretien – L'utilisateur ne doit pas tenter d'effectuer l'entretien de l'enceinte au-delà de ce qui est décrit dans les consignes de fonctionnement.
18. L'appareil ne doit pas être exposé à un ruissellement ou à un giclage d'eau; des objets remplis de liquides comme des vases, ne doivent pas être placés sur l'appareil.
19. Le dispositif de débranchement (l'entrée d'alimentation) doit demeurer aisément accessible.

Toute autre réparation doit être confiée à du personnel qualifié.

**Vorsicht**

Um der Gefahr von Stromschlägen vorzubeugen, das Gehäuse (bzw. die Rückwand) nicht abnehmen. Im Inneren befinden sich keine Teile, die vom Benutzer gewartet werden können. Reparatur- und Wartungsarbeiten nur von entsprechend qualifizierten Kundendiensttechnikern durchführen lassen.

Das Symbol „Blitz mit Pfeilspitze“ soll den Benutzer warnen, dass im Gehäuse des Produkts eine nicht isolierte „gefährliche Spannung“ vorhanden ist, die so hoch sein kann, dass die Gefahr von für Menschen gefährlichen Stromschlägen besteht.

Das Symbol „Ausrufezeichen“ soll den Benutzer auf wichtige Bedienungs- und Wartungshinweise in der Begleitdokumentation des Subwoofers aufmerksam machen.

1. Anweisungen durchlesen – Lesen Sie sämtliche Sicherheits- und Bedienungshinweise, bevor Sie den Subwoofer in Betrieb nehmen.
2. Anweisungen aufbewahren – Bewahren Sie die Sicherheits- und Bedienungshinweise zum späteren Nachschlagen auf.
3. Warnungen beachten – Berücksichtigen Sie alle Warnungen auf dem Subwoofer und in der Bedienungsanleitung.
4. Anweisungen befolgen – Folgen Sie Bedienungs- und Verwendungshinweisen.
5. Wasser und Feuchtigkeit – Verwenden Sie den Subwoofer nicht in der Nähe von Wasser – z. B. an Badewannen, Wasch- oder Spülbecken, in einem feuchten Keller, am Schwimmbeckenrand o. ä.
6. Rollwagen und Ständer – Der Subwoofer sollte nur mit einem vom Hersteller empfohlenen Wagen oder Ständer verwendet werden.
7. Wand- oder Deckenmontage – Eine Wand- oder Deckenmontage des Subwoofers darf nur gemäß den Herstellerempfehlungen erfolgen.
8. Belüftung – Der Subwoofer muss so positioniert werden, dass am Installationsort eine unbehinderte Luftzirkulation möglich ist. Beispielsweise darf der Subwoofer nicht auf einem Bett, Sofa oder Teppich oder auf einer ähnlichen Oberfläche aufgestellt werden, die die Belüftungsöffnungen abdeckt; auch die Aufstellung in einem Bücherregal oder Schrank ist nicht zulässig, wenn dies den Luftstrom durch die Belüftungsöffnungen behindern würde.
9. Wärme – Der Subwoofer darf nicht in der Nähe von Wärmequellen wie Heizkörpern, Heizluftausströmern, Öfen oder weiteren Wärme abstrahlenden Subwoofern installiert werden.
10. Stromversorgung – Der Subwoofer darf ausschließlich an eine Stromversorgung mit den Daten angeschlossen werden, die in der Bedienungsanleitung angegeben oder auf dem Subwoofer aufgedruckt sind.
11. Schutz des Netzkabels – Netzkabel müssen so verlegt werden, dass keine Personen darauf treten und dass sie nicht von darauf oder daneben abgestellten Gegenständen gequetscht werden können. Besonders gefährdet sind die Kabel in der Nähe von Steckern und Steckdosen sowie am Gehäuseeintritt in den Subwoofer.
12. "Vorsicht: Zur Vermeidung von Stromschlägen muss der breite Steckerkontakt vollständig in den breiten Schlitz eingeführt werden."
13. Reinigung – Der Subwoofer darf nur gemäß den Herstellerempfehlungen gereinigt werden.
14. Nichtbenutzung – Das Netzkabel des Subwoofers sollte von der Steckdose abgezogen werden, wenn das Gerät längere Zeit nicht verwendet wird.
15. Eindringen von Gegenständen und Flüssigkeiten – Achten Sie darauf, dass keine Gegenstände in das Gehäuse fallen und keine Flüssigkeiten darüber verschüttet werden.
16. Zu reparierende Schäden – In den folgenden Fällen muss der Subwoofer durch den qualifizierten Kundendienst repariert werden:
 - a. Das Netzkabel oder der Netzstecker wurde beschädigt.
 - b. In den Subwoofer sind Gegenstände gefallen, oder Flüssigkeit wurde darüber verschüttet.
 - c. Der Subwoofer ist im Regen nass geworden.
 - d. Der Subwoofer scheint nicht wie gewohnt zu funktionieren oder weist eine deutlich veränderte Leistung auf.
 - e. Der Subwoofer wurde fallen gelassen oder beschädigt.
17. Wartung – Versuchen Sie nicht, Wartungsarbeiten am Subwoofer durchzuführen, die über den Umfang der in der Bedienungsanleitung beschriebenen Maßnahmen hinausgehen.
18. Das Gerät darf keinem Tropf- oder Spritzwasser ausgesetzt werden, und es dürfen keine mit Wasser gefüllten Gegenstände wie Vasen darauf abgestellt werden.
19. Die Trennstelle (die Gerätesteckdose) muss stets leicht bedienbar (gut zugänglich) sein.

Alle darüber hinausgehenden Wartungsmaßnahmen dürfen ausschließlich von entsprechend geschulten Fachkräften durchgeführt werden.



Attenzione

Per ridurre il pericolo di scossa elettrica, non togliere il coperchio (o la parete posteriore). L'interno non contiene parti su cui l'utente possa intervenire. Per assistenza e riparazioni, rivolgersi a personale tecnico qualificato.

Il simbolo con la freccia forma di fulmine avvisa l'utente della presenza di "tensioni pericolose" all'interno della cassa del prodotto, non isolate e di intensità sufficiente a configurare un pericolo di scossa elettrica per le persone.

Il simbolo con il punto esclamativo avvisa l'utente della presenza di importanti istruzioni di uso e manutenzione nella documentazione che accompagna il subwoofer.

1. Leggere le istruzioni — Prima di usare il subwoofer, leggere tutte le istruzioni di uso e sicurezza.
2. Conservare le istruzioni — Conservare le istruzioni di uso e sicurezza per riferimento futuro.
3. Rispettare le avvertenze — Osservare tutte le avvertenze presenti sul subwoofer e contenute nelle istruzioni.
4. Seguire le istruzioni — Seguire tutte le istruzioni di uso e funzionamento.
5. Acqua e umidità — Il subwoofer non deve essere usato in vicinanza di acqua — ad esempio vicino a vasche da bagno, lavandini, lavelli, lavatoi, in seminterrati umidi, vicino a piscine, o altro.
6. Carrelli e supporti — Il subwoofer deve essere usato solo con un carrello o supporto raccomandato dal produttore.
7. Montaggio a parete o a soffitto — Il subwoofer deve essere montato su pareti e soffitti solo come raccomandato dal produttore.
8. Ventilazione — Il subwoofer deve essere posizionato in modo da non pregiudicare la ventilazione. Ad esempio, non deve essere collocato su letti, divani, tappeti o qualunque superficie del genere che possa ostruire le fessure di ventilazione; inoltre non deve essere montato a incasso, come in librerie o mobiletti, in modo da ostacolare il flusso dell'aria attraverso le fessure di ventilazione.
9. Calore — Il subwoofer deve essere collocato lontano da sorgenti di calore come radiatori, diffusori di aria calda, stufe, o altri subwoofer che generano calore.
10. Sorgenti di alimentazione — Il subwoofer deve essere collegato solo a una sorgente di alimentazione del tipo descritto nelle istruzioni per l'uso o indicata sul subwoofer stesso.
11. Protezione dei cavetti di alimentazione — Disporre i cavetti di alimentazione in modo che non possano essere calpestati o schiacciati da oggetti collocati sopra o contro di essi, facendo particolare attenzione vicino alle spine, alle prese, e nei punti in cui i cavetti escono dal subwoofer.
12. "Attenzione: per evitare scosse elettriche, inserire a fondo la lamella larga della spina nella fessura larga della presa."
13. Pulizia — Pulire il subwoofer solo come raccomandato dal produttore.
14. Periodi di non uso — Quando non si usa il subwoofer per un lungo periodo di tempo, staccare dalla presa elettrica il cavetto di alimentazione.
15. Penetrazione di liquidi e oggetti — Evitare con attenzione la caduta di oggetti e la penetrazione di liquidi all'interno della cassa.
16. Danni che richiedono manutenzione — Il subwoofer deve essere riparato da personale tecnico qualificato in caso di:
 - a. danni al cavetto o alla spina di alimentazione;
 - b. caduta di oggetti e penetrazione di liquidi all'interno della cassa;
 - c. esposizione del subwoofer alla pioggia;
 - d. funzionamento anomalo o notevole cambiamento nelle prestazioni del subwoofer;
 - e. caduta o danni del subwoofer.
17. Manutenzione — L'utente non deve provare a intervenire sul subwoofer oltre quanto descritto nelle istruzioni per l'uso.
18. L'apparecchiatura non deve essere esposta a schizzi o gocciolamento di acqua e su di essa non devono essere collocati oggetti contenenti liquidi, come ad esempio vasi.
19. Il dispositivo di disconnessione (la presa di alimentazione) deve rimanere facilmente azionabile (facilmente accessibile).

Per tutti gli altri interventi, rivolgersi a personale tecnico qualificato.

TABLE OF CONTENTS

Congratulations	1
Before you Begin	1
Package Contents	2
Product Features and Controls	2
- SMS-1	2
- Remote Control	3
- Digital Drive Accessory Kit	5
Installation Overview	5
SMS-1 Controls and Ports	5
Installation – Quick Start	8
Installation – Step-by-Step	9
- SMS-1 Cable Connections	9
- A Word About SMS-1 Outputs	9
- A Word About Interconnect Cables	10
- A Word About Connecting more than one SMS-1	10
SMS-1 Setup - OVERVIEW	12
- Quick Setup Using Self-EQ	12
- ON-SCREEN Setup	12
Onscreen Programming and Setup – Step by Step	17
Restoring Defaults	34
Runtime Mode	35
About Room Equalization	38
Care of Your Digital Drive SMS-1	38
Troubleshooting and Service	38
Appendix A: RS-232 Serial Overview and Commands	39
Appendix B: Summary of Special Remote Codes	41

CONGRATULATIONS

Congratulations on your purchase of a Velodyne Digital Drive SMS-1 Subwoofer Management System! This system enables you to bring the power of Velodyne's patent-pending Digital Drive bass management to any subwoofer. Digital Drive technology, universally acknowledged as the state-of-the-art in bass reproduction, is the result of years of research and development, combining advanced Digital Signal Processing (DSP), software, equalizer, and audio filter technologies. The result is a product that provides levels of bass management for non-DD subwoofers previously unattainable.

This exceptional product will provide you with years of unparalleled listening pleasure. **Enjoy!**

BEFORE YOU BEGIN

Please observe the following instructions to insure safe and proper system operation.

Warning!

To prevent fire or shock hazard, do not expose this equipment to rain or moisture. To avoid electrical shock, do not open the chassis cover. Please observe all warnings on the equipment itself. There are no user serviceable parts inside. Please refer all service questions to your authorized Velodyne dealer.

Prior to installation

Please unpack the system carefully! Remove all staples if used to seal the carton as they can scratch the chassis. Please save the carton and all packaging materials for future use. Packing this unit in any other carton may result in damage when shipping. Please take a moment to record the serial number and date/location of purchase in the space provided on the warranty card for future reference or register on-line at www.velodyne.com.

NOTE: Be sure to check the Velodyne website at www.velodyne.com for updates to the SMS-1 software and/or this manual.

Caution!

This SMS-1 has electronics built into the cabinet. Do not place the cabinet next to sources of heat such as furnace registers, radiators, etc. Do not place the unit near sources of excessive moisture, such as evaporative coolers, humidifiers, etc. The power cord should be routed in such a way that it will not be walked on, pinched, or compressed in any way that could result in damaging the insulation or wire.

PACKAGE CONTENTS

Your Velodyne Digital Drive SMS-1 consists of the following components:

- Digital Drive SMS-1
- Power Supply with Cord
- Remote control
- Digital Drive Accessory Kit

CAUTION: *Many of the accessories are embedded in the included foam endcaps. Please do not discard.*

PRODUCT FEATURES AND CONTROLS

SMS-1

Prominent features of your new Digital Drive SMS-1 include:

- Front panel display indicating volume, preset, and operating modes (auto-EQ, mute, night mode)
- Control for up to three subwoofers
- Balanced (XLR) input
- Line-level (RCA) inputs and thruputs
- Speaker-level inputs
- Fixed 80Hz high-pass crossover (RCA output)
- Variable volume control
- Detachable 6-foot power supply
- Included rack mount ears
- On-screen controls:
 - Auto-EQ
 - Graphic or Parametric Equalizer controls for room EQ
 - Adjustable (15Hz – 199Hz) low-pass crossover (defeatable)
 - Multiple staggered low-pass crossovers (6dB/octave, initial to 48dB/octave, ultimate)
 - Adjustable (15Hz - 35Hz) subsonic filter (defeatable)
 - Multiple staggered subsonic filters (12dB/octave, initial to 48dB/octave, ultimate)
 - Variable volume control
 - Adjustable phase control (0° - 180° in 15° increments)
 - Selectable polarity (+/-)
 - 12 Volt trigger (defeatable)
 - 6 presets for customized listening modes and EQ defeat
 - Selectable default preset
 - Switchable LCD light
 - Night Mode maximum volume setting
 - Save settings indicator
 - Daisy chain feature

Remote Control

The Velodyne Digital Drive infrared remote control allows you to set up, adjust, and reset your SMS-1 when connected to a television or a video monitor. You will also use your remote to activate preset listening values, set the SMS-1's volume up or down, mute the SMS-1, or set a night operational mode.

Take care not to lose or misplace your remote control as adjustments to the SMS-1 (with the exception of volume control) can only be done using the remote.

NOTE: Two 1.5V AA batteries are required and included for operation of the remote control.

Remote Control Buttons

A brief description of each button on the remote control follows:



- **PWR** – Causes the SMS-1 to stand by.
- **NUMERIC KEYPAD** – Used to enter an unlock code to enter SETUP mode, and for other functions.
- **SET (+/-)** – Increases or decreases the Q value for a parametric EQ, or sets values on the SYSTEM SETTINGS page.
- **LIGHT** – Turns the SMS-1's LCD light on or off.
- **NIGHT** – Limits the peak output of the SMS-1, and illuminates the NIGHT indicator on the LCD screen.
- **VOL (+/-)** – Raises or lowers the volume of your SMS-1 as indicated on the LCD display.
- **MUTE** – Mutes and unmutes the SMS-1.
- **TEST** – Used to toggle between the SYSTEM SETTINGS screen and the SYSTEM RESPONSE screen during setup.
- **EXIT** – To exit SETUP mode. The unit will ask if you want to save settings before exiting.
- **SELECT** - To toggle field values.
- **RESET** – Used to reset volume to the last saved setting on the main screen, and to defeat crossovers on the settings screen.
- **MENU** – Enters SETUP mode from the introductory screen.
- **PRESETS** – To access the five presets and one EQ defeat listening modes. Initially set at the factory, they are fully user adjustable. The front panel LCD indicates which preset you have selected.

Figure 1: Velodyne Digital Drive remote control

Digital Drive Accessory Kit

The Velodyne Digital Drive Accessory Kit contains the following six components:

- Calibrated precision microphone
- Microphone windscreen cover
- Tabletop microphone stand
- Microphone stand adapter
- 6 foot audio cable
- 6 foot video cable
- 20-foot XLR microphone cable

INSTALLATION OVERVIEW

Your new Velodyne SMS-1 provides for a number of installation options. Read all the installation information below in order to determine which installation option is best for your system. **Remember to perform all installation procedures with SMS-1 unplugged until instructed to activate it!**

SMS-1 Controls and Ports

The Velodyne Digital Drive SMS-1 is set up, configured, and adjusted by the controls, inputs, and connections located on the rear panel of the unit. Figure 1 shows the location of each of these important operational interfaces. Brief descriptions of each interface follow.

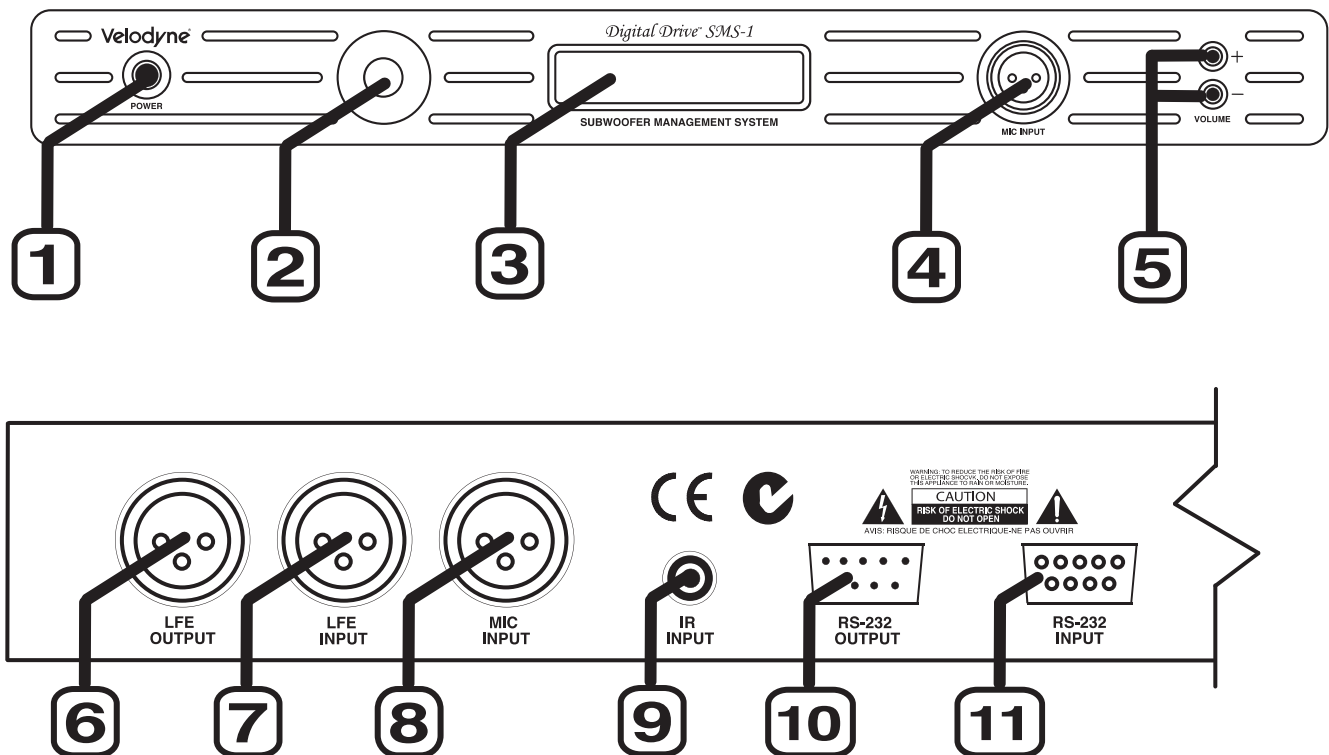

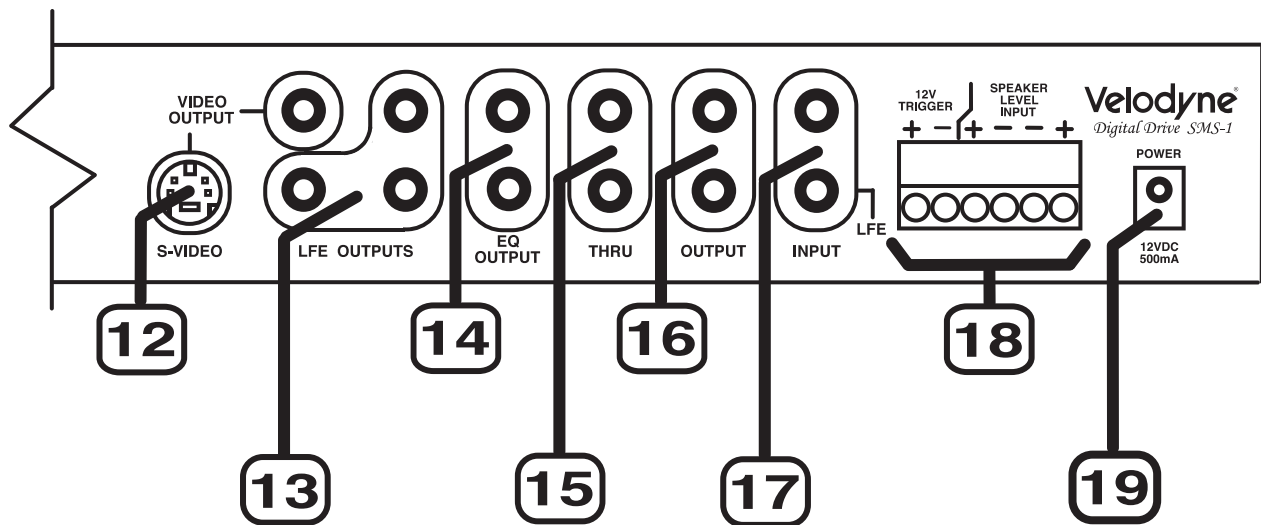

Figure 2: Digital Drive Front and Rear Panel Connections

- (1) POWER – Press the POWER switch to the ON position to activate the SMS-1. If the unit is to be left unused for an extended period of time, press the switch to the OFF position to prolong the life of the SMS-1.
- (2) IR Remote Sensor.
- (3) LCD Display – This display shows subwoofer volume, preset, and indicates auto-EQ, self-EQ, mute, and night mode operation.
- (4) MIC INPUT – This XLR input jack is for the XLR microphone cable.
- (5) VOLUME UP/DOWN – Press the black UP pushbutton to incrementally raise your SMS-1's system volume; press the black DOWN pushbutton to incrementally lower your SMS-1's system volume. Note the use of these buttons during software updates.
- (6) XLR OUTPUT – This balanced connector sends the conditioned subwoofer audio signal to your subwoofer.
- (7) LFE INPUT – This XLR input jack receives the LFE signal from your receiver or processor.
- (8) MIC INPUT – This XLR input jack is for the XLR microphone cable.
- (9) IR REMOTE – This connection allows for hook-up of an IR signal from a repeater or other similar device.

- (10) RS-232 OUT – Use this port to communicate with a second “daisy-chained” Digital Drive SMS-1.
- (11) RS-232 IN – Use this port to communicate with your computer (for software updates), a touch panel remote control, or another upstream Digital Drive SMS-1. See Appendix A for an explanation of the use of the serial port, available commands, and their formats.
- (12) EQ Video Output – Used to display the video generated by the SMS-1. S-Video or composite connections are available. A composite video cable is included. NOTE: Only connect to a single video output at a time.
- (13) LFE OUTPUT – These connectors send the conditioned subwoofer audio signal to up to three subwoofers.
- (14) EQ OUTPUT LEFT/RIGHT – Connect the audio cable from your accessory kit to these jacks: white plug to LEFT, and red plug to RIGHT.
- (15) THRU – These RCA connectors are for sharing the same signal that goes into your SMS-1 with a second “daisy-chained” SMS-1 or other device. Unaltered line-level signal comes out of the THRU jack.
- (16) OUTPUT – These RCA connectors incorporate the use of an 80Hz 6 dB/octave slope high pass crossover.
- (17) INPUT LFE – These RCA input jacks are for line-level connection.
- (18) 12V TRIGGER/SPEAKER LEVEL INPUT RIGHT/LEFT – If the 12 volt trigger mode is active, 12 volts is required across these pins for power to be activated. The speaker-level connector allows for connection with exposed speaker wire.
- (19) 12V DC POWER SUPPLY INPUT - Connect the power supply to this jack.

INSTALLATION – QUICK START

To quickly set up and take advantage of the auto-EQ feature in your new Digital Drive SMS-1, perform the following steps:

1. Unpack the SMS-1 and connect the power cable.
2. Connect an LFE input cable from your receiver/processor to the input jack. For other hookup options, see step 2 on page 9.
3. Connect a high quality line level cable from one of the LFE out jacks to your subwoofer.
4. Disable your subwoofer's crossover if possible, and set its volume to one-quarter up to one-half setting.
5. Power up the unit and ensure that it is receiving and processing signal from your receiver (i.e. your subwoofer is playing bass).
6. Connect the microphone (found in the accessory kit) to the XLR mic input jack on the front or rear panel of the SMS-1 and place the mic in your favorite listening position.
7. Press 3-2-1 on the remote.
8. The subwoofer should emit 25 "sweep" tones then restart and play normally. NOTE: If you have the video connected you will see the sweep screen with Self-EQ mode indicated. This screen will show the EQ adjustments as they happen.
9. Adjust the SMS-1's volume and your subwoofer's volume to taste.
10. Enjoy your room-equalized sub!

INSTALLATION—STEP-BY-STEP

To ensure a quick and flawless installation of your Velodyne Digital Drive SMS-1, follow these setup instructions.

SMS-1 Cable Connections

Make all necessary cable connections between the applicable SMS-1 connector port and your particular home electronics equipment in the following order:

1. Insert the detachable power supply into the power interface port on the rear panel of your SMS-1. Plug the male end of the cord into a convenient wall outlet.
2. Provide signal to your SMS-1 through one or more of the following connections (refer to your receiver/processor owner's manual for available inputs to the SMS-1):
 - a. LFE INPUT (RCA, the RED jack at location 17 on Figure 1) – This is the most common input cable connection. Make a connection between this input and the LFE output of your receiver or processor; OR
 - b. LFE INPUT (XLR, location 7 on Figure 1) – Make a connection between this input and the balanced LFE outputs of your receiver or processor; OR
 - c. INPUT, LEFT and RIGHT (location 17 on Figure 2)– Make a connection between these inputs and the stereo outputs of your receiver or processor; OR
 - d. SPEAKER-LEVEL INPUT (location 18 on Figure 2) - Make a connection between these inputs and the left and right speaker connections on your receiver or processor. Make this connection by inserting speaker wire into the correct terminals of the terminal block.
3. Establish the return line-level connection (optional). Connect to a pre-amplifier's main outputs and return them to your amplifier inputs. When installed in this fashion, your satellite speakers will be crossed over at 80Hz, which removes the lower bass from your amplifier and speakers, enabling them to do a better job reproducing high frequencies. By utilizing this method, you will have a bi-amplified system, gaining improved power and headroom for your system.

NOTE: To bypass the 80Hz crossover described in step 3, use the THRU output jacks instead of the OUTPUT jacks.

A word about SMS-1 outputs

The Velodyne SMS-1 is designed to operate using the full range audio signal for input when using the digital built-in crossover. Most processors/receivers have a "subwoofer out" or LFE jack that is internally filtered and designed to be used with a conventional amplifier and speaker. In some rare cases, combining both an external crossover and the one internal to the SMS-1 may result in low output and increased noise. In these installations you may need to bypass the internal crossover in either the processor or Velodyne SMS-1. In some installations, simply setting one crossover to a higher frequency (such as 120Hz) will restore maximum performance. To bypass the SMS-1's internal crossover when the unit is being fed a low pass signal from another crossover, refer to the SETUP instructions at step 14, below.

Note: If not using an external crossover, you should use the built-in crossover for optimal performance.

4. Connect the audio/video cables between your SMS-1 (EQ OUTPUT VIDEO/LEFT/RIGHT – yellow, white, and red respectively) and your electronics (receiver, processor, TV, etc.). Insert the color-coded cable plugs into the correct EQ OUTPUT receptacle – the yellow plug into the VIDEO jack, the white plug into the LEFT jack, and the red plug into the RIGHT jack. The opposite ends of the cables should be connected to your receiver/processor. The yellow VIDEO cable goes to an available composite video input (e.g. aux), and the white/red AUDIO (L&R) cables go to a corresponding audio input. As an alternative to composite video, you may want to use S-video (S-video connector not included). Connect the S-video from the SMS-1 to an S-video compatible input on either your processor or TV. Consult your receiver/processor and/or TV owner's manual for more information.
5. Connect your subwoofer(s) to the SMS-1 using the XLR connector or LFE out RCA connector.
6. Defeat the crossover on your subwoofer(s) (if possible) and set its volume to the middle setting.

NOTE: Make sure the audio output goes into your AUDIO system, not your TV! The SMS-1 will generate test tones used to match the SMS-1 to your satellites and to correct for room anomalies that need to be played by your main audio system.

7. Insert the XLR microphone cable's 3-pin male plug into the MIC INPUT jack (location 7 on Figure 2) on the front or back panel of the SMS-1.
8. Slide the microphone (male connector end first) down through the open, circular sleeve of the tabletop microphone stand. Position this assembly at a desired listening position.

NOTE: The Digital Drive Accessory Kit includes a microphone stand adapter (1/2"-27 thread) for use with professional mounting stands. Be sure to first remove the inner thread piece (3/8"-16) before using.

9. Connect the XLR microphone cable's female jack end with the male connector end of the microphone.
10. Sheath the microphone pickup with the foam windscreen cover as a protection against dirt and airborne contaminants.

A Word About Interconnect Cables

When installing your new Velodyne SMS-1 using the line level connections, you should always use shielded phono cables. There are many quality cables available today, most any of which will work perfectly well. We do recommend that you keep the length of cable as short as possible to avoid any potential noise problems.

A Word About Connecting more than one SMS-1

Note that your SMS-1 can control up to three subwoofers. Each of the three subwoofers will receive the same conditioned signal from the SMS-1. If you wish to run more than three subwoofers, or wish to individually customize the signal to different subwoofers, you will need more than one SMS-1 connected in a "daisy-chain" configuration. This section describes setup in a daisy-chain configuration.

Choose one SMS-1 for all the connections described below (we'll call this the "master"), and then connect an RCA jack from the THRU RCA jacks of the "primary" to the Input jacks of the "slave." You will also need to obtain a "Mouse Extension" serial cable (available at any computer store, from your Authorized Velodyne dealer, or from Velodyne directly) and connect the RS232 OUT port of the primary SMS-1 to the RS-232 IN port of the secondary SMS-1. Then, all runtime commands directed at the primary SMS-1 (such as select preset, volume, etc.) will be communicated to the secondary SMS-1 automatically through the serial cable. If you have more than two SMS-1s in your setup, simply continue the daisy chain from the secondary SMS-1 to the next SMS-1 in the line (using both RCA and serial connections) and so on.

NOTE: When an SMS-1 detects an incoming RS-232 command, it reverts to "Slave Mode." This means that the SMS-1 will no longer accept IR commands. To reestablish normal operations, disconnect the RS-232 cable and power cycle the unit.

Note that the daisy chain connection ONLY allows the woofers to communicate basic "run-time" commands such as volume and preset. We recommend the following sequence when setting up daisy-chained SMS-1s.

1. First, connect only the master SMS-1/subwoofer(s) to the system. Do not connect the thru or serial cables at this time.
2. Establish the crossover, phase, and other settings EXCEPT the EQ on the master SMS-1/subwoofer(s) (see setup steps 1 – 17 below). Note the low pass crossover, phase and polarity settings, then save.
3. Connect the video out of the slave SMS-1/subwoofer(s), go to the settings screen, establish the low pass crossover, slope, phase, polarity, and night mode settings from the master SMS-1, then save settings.
4. Connect the microphone to the slave SMS-1/subwoofer(s) and use the "self-EQ" feature (described below) to establish room EQ for that SMS-1.
5. Repeat steps 3 and 4 for each slave SMS-1/subwoofer(s) in your system.
6. Reconnect the video out to the master SMS-1/subwoofer(s), and reconnect the thru and serial cables so that the master and slave SMS-1(s) are daisy chained.
7. EQ the primary SMS-1/subwoofer(s) (see steps 8-25). Self-EQ is NOT recommended for the primary SMS-1/subwoofer(s).
8. Setup is complete!

SMS-1 SETUP – OVERVIEW

BEFORE YOU BEGIN: Once the installation has been completed, note that you can use your SMS-1 without performing ANY of the setup steps below. Simply use the remote to set the volume, and select the preset that most closely matches your listening material, and enjoy! However, to reap the maximum benefits of Digital Drive technology, read on!

Special note for 230V users with video problems

For 230-volt Digital Drive SMS-1 users, the default video mode is NTSC video format. If your TV is NTSC compatible, you will have no trouble with this mode. However, certain TVs (especially older ones) may require PAL or SECAM video. To switch from NTSC to PAL/SECAM mode, press the DOWN ARROW four times followed by RESET. The SMS-1 will restart in PAL/SECAM video mode. To revert back to NTSC, restore defaults by pressing 8-9-0 on the cover screen.

Quick Setup Using Self-EQ

To perform an abbreviated setup of your Digital Drive SMS-1 using the Self-EQ function, position the microphone in your listening position and connect it to the SMS-1 as shown in the installation instructions. Then, press 3-2-1 on the remote. The subwoofer emits 25 “sweep tones” that are detected by the microphone and used to automatically EQ your SMS-1 accordingly. After the sweep tones are completed, the unit automatically saves settings and returns to normal operation. Once the self-EQ process starts, pressing the RESET button can interrupt it.

Caution: Self-EQ resets all EQs for all presets to their default values. DO NOT use the Self-EQ feature after you have adjusted the SMS-1 EQs manually as described below.

ON-SCREEN Setup

This section describes adjusting the onscreen settings of your SMS-1. You will be performing all the setup functions using the buttons of your Velodyne-supplied remote control and seeing the results on your TV screen. Words in all uppercase letters in the setup instructions (e.g., SELECT, MENU, etc.) identify the specific remote button to be pressed or selected, or the field on the screen you should be paying attention to. Remember to point the remote control at the SMS-1, not your TV!

Use the UP, DOWN, RIGHT, and LEFT directional arrow buttons that surround SELECT to navigate the fields of the setup screens. Settings are typically changed using the SELECT key, followed by the UP and DOWN arrow keys. Alternatively, the SET +/- buttons can be used to change settings. A screen field highlighted in reverse video indicates your current location on the screen. Holding down the UP, DOWN, RIGHT, or LEFT arrow keys causes the remote to repeat and you can then rapidly move through fields to arrive at the desired one. You should be able to perform most of the setup process by using the four arrow keys and the SELECT button.

WARNING: The SMS-1 is a device that manipulates your subwoofer’s input audio signal before passing it along to the subwoofer to play. There are tools and controls on the SMS-1 that allow you to send signals to your subwoofer that your subwoofer may not be able to handle. Many subwoofers contain self-protection but even this might not be enough to handle certain conditioned signals. Use caution when setting subsonic filters, EQs, volume levels, and other settings so that you do not send signals to your subwoofer that cause it harm. Areas of particular concern will be highlighted throughout the setup instructions.

NOTE: Velodyne is not responsible for damage caused to subwoofers as a result of normal use and setup of the SMS-1.

Following is an overview of the screens you will be using to set up your Velodyne Digital Drive SMS-1.

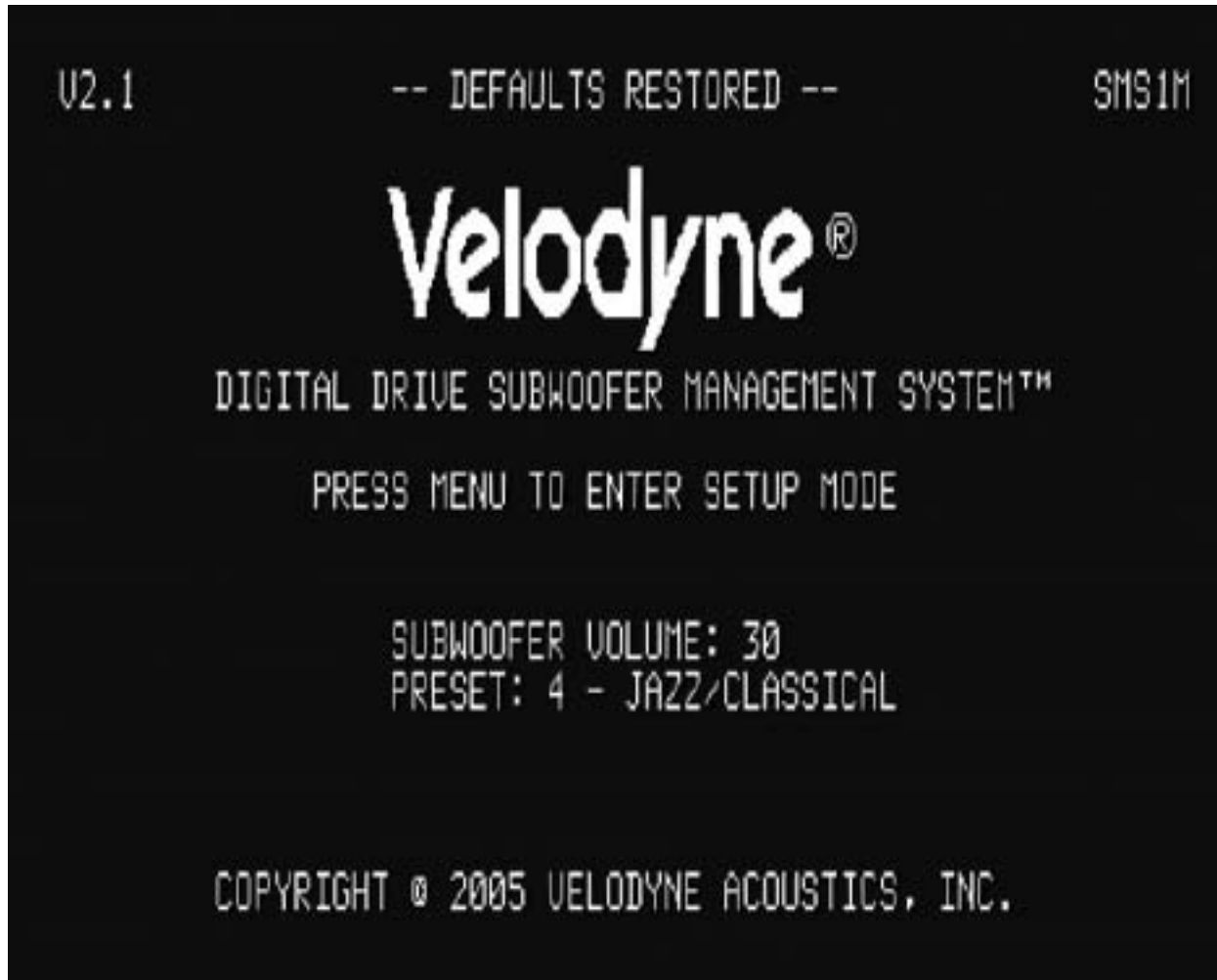

Figure 3: Introductory Screen

See Figure 3. This is the Introductory screen. Notice that as you change settings (such as preset, volume, etc.) they are shown on this screen.

You enter setup mode by pressing MENU and entering the code 12345. Upon successful entry of this code, the system takes you to the EQ Setup screen, as shown in Figure 4.

HINT: You do not need to press MENU to begin entering the setup code. You can begin the 12345 sequence by pressing the number 1 on the remote.

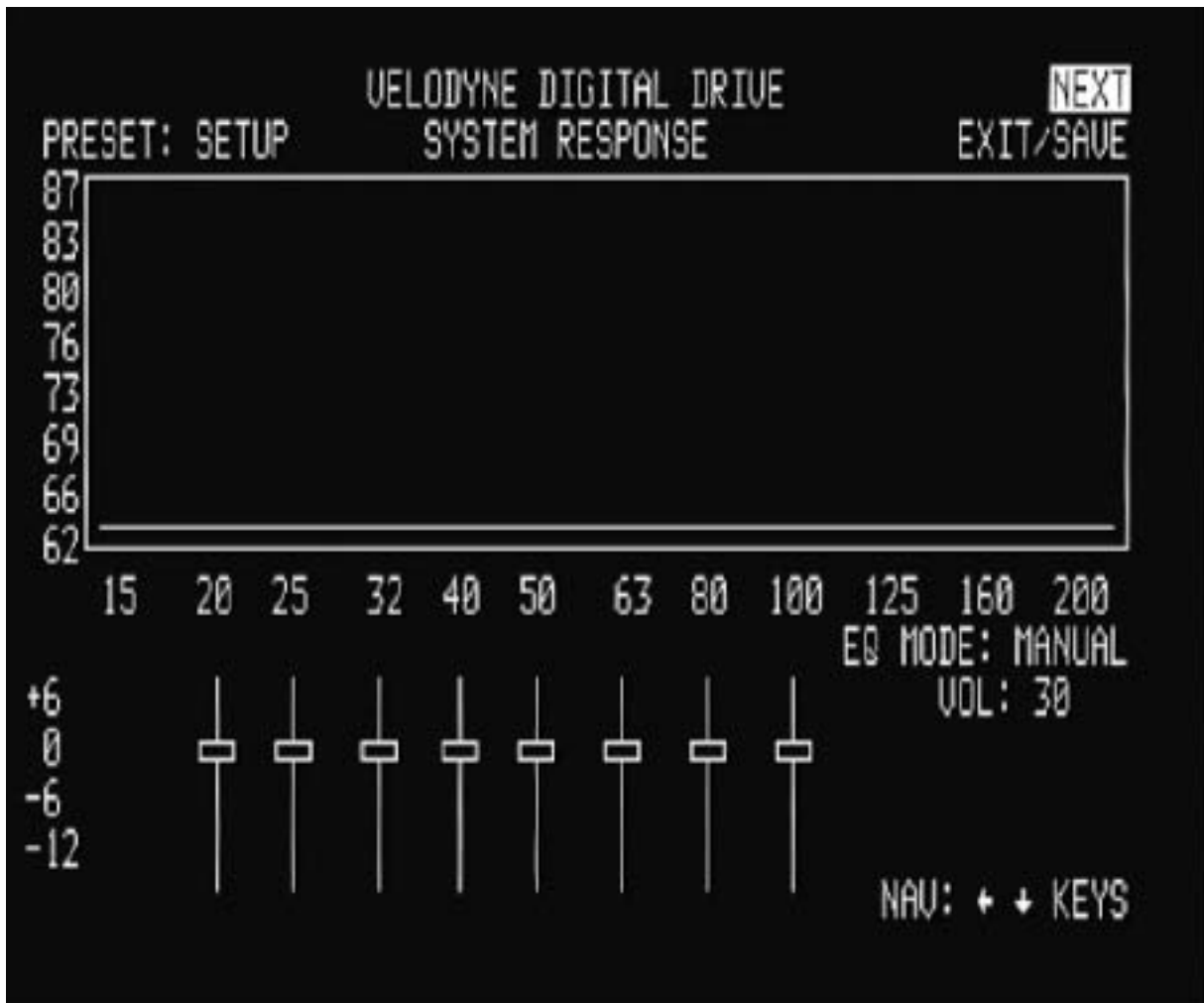

Figure 4: EQ Setup screen

The EQ Setup screen includes a “SYSTEM RESPONSE” “sweep” window and a graphic equalizer. You use these settings to equalize your room. The graphic equalizer features 8 bands, each of which can be used at its current frequency, or can be infinitely adjusted to the frequency and Q you desire. Each preset can have its own EQ settings.

By navigating the cursor to the NEXT field and pressing SELECT, the following screen appears:

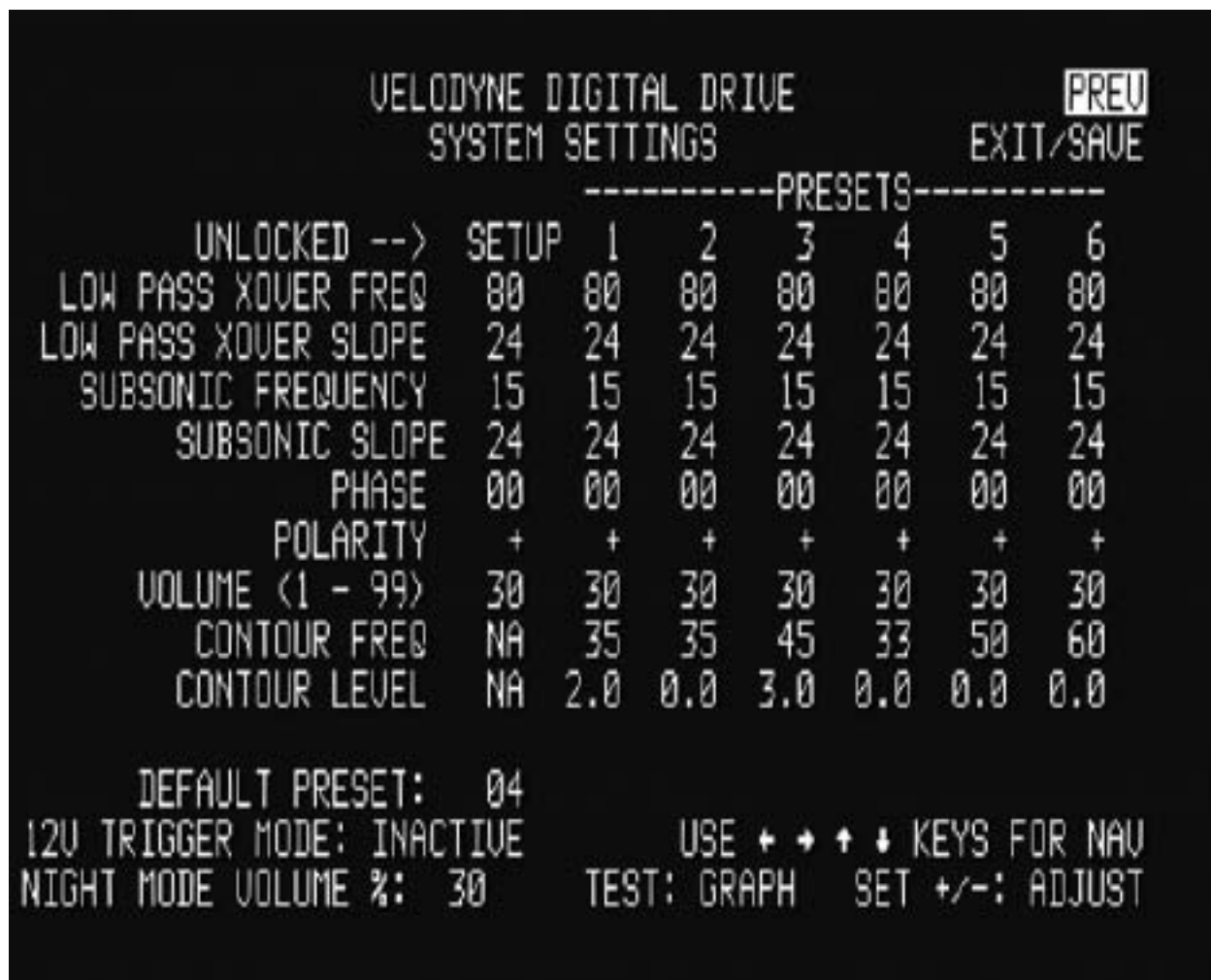

Figure 5: SYSTEM SETTINGS Screen

From this screen the crossover, subsonic filter, phase, polarity, volume, and other settings can be set, as well as specifics for each preset, if desired.

Your SMS-1 comes with 6 presets, four of which are preprogrammed at the factory. The Setup setting is used to initially set the crossovers, slopes, phase, polarity, and volume for all presets. Then, each preset can be individually adjusted if desired. The presets are as follows (they are also labeled on the remote):

1. Action/Adventure
2. Movies
3. Pop/Rock
4. Jazz/Classical
5. Custom (off from the factory, or flat)
6. EQ Defeat

All six presets contain the following fields:

- **Low Pass Crossover Frequency and Slope** – Adjust the upper limit of your SMS-1's frequency response. Select a crossover setting, in increments of 1, between 15 Hz and 199 Hz (or OFF) and slope at 6, 12, 18, 24, 30, 36, 42 and 48 dB/octave.
- **Subsonic Filter Frequency and Slope** – Set your SMS-1's subsonic filter (low frequency limit), in increments of 1, between 15 Hz – 35 Hz and slope at 6, 12, 18, 24, and 48 dB/octave.
- **Phase** – Set the phase (delay) of the SMS-1's output signal, 0 to 180 degrees (adjustable in 15 degree increments).
- **Polarity** – Set your SMS-1's polarity by toggling between positive (+) or negative (-). This in effect reverses the phase 180 degrees.
- **Volume** – Each preset can have its own volume separate from the master volume shown in the setup column. When the master volume changes, the preset volume changes in lock step.
- **Contour Frequency** – This allows you to set a frequency to boost or cut the signal to your SMS-1 in response to specific types of source material. These have been preset at the factory according to the presets above, but any or all can be customized to taste.
- **Contour Level** – This indicates the amount of boost or cut at the frequency specified in the contour frequency. Again, this has been preset at the factory but can be adjusted to taste.

Other controls on the Setting Setup Screen:

- **12 Volt Trigger Mode** – When active, this control automatically shuts the SMS-1 off until 12 volts is detected via the connector at position 18 on the back panel.
- **Night Mode Maximum Volume** – When the NIGHT mode button is pressed on the remote, this setting is invoked. Night mode is indicated on the LCD display. The SMS-1 will not play louder than this volume level until the night mode is defeated.

ONSCREEN PROGRAMMING AND SETUP— STEP-BY-STEP

The following steps take you through a typical SMS-1 setup procedure.

1. Push the POWER button on the SMS-1's front panel to activate the unit.
2. Make sure your receiver/processor is on and the volume control is set to minimum.
3. If you haven't already done so, establish the crossover settings for your main speakers. Generally, if your mains can be crossed over at 80 Hz (that is, accurately reproduce frequencies to this level) it is an ideal setting. However, some satellite speakers are only flat to 120 Hz or even higher. Remember that the higher the SMS-1 is crossed over (to match the satellite crossover settings), the more likely it is to become directional (that is, you can tell where the bass is coming from). Again, consult your processor and speakers owner's manuals for more information.
4. Select the source on your receiver/processor that the DD SMS-1 audio output is connected to. Input should be configured for stereo.
5. Set the video input where you connected the video output as the active TV image. The introductory screen with the Velodyne logo and "Velodyne Digital Drive" should now appear on your TV screen, as follows:



6. Press MENU and enter 12345 to enter the EQ setup screen, as follows:



Upon pressing 5, you should see the following screen:

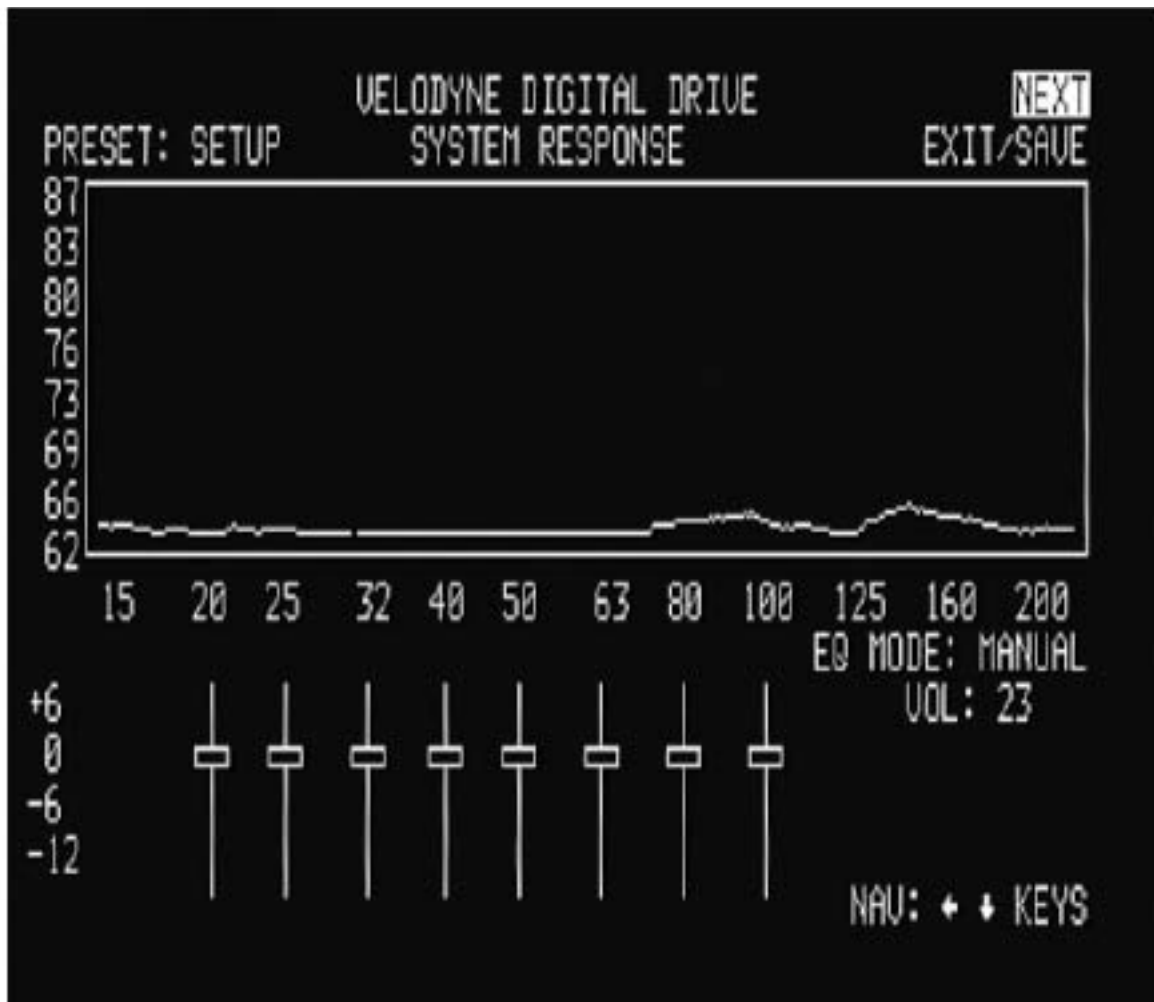

7. Use the remote control to MUTE the SMS-1.

8. Raise the volume on your receiver/processor until the DD test sweep (a tone that sweeps from 20 Hz up to 200 Hz) can be heard from your system's speakers. Continue to raise the volume until the "SYSTEM RESPONSE" graph on your TV shows the response of your full range speakers (the right hand portion of the graph) at approximately 86 dB (or a comfortable listening level). This is shown below:

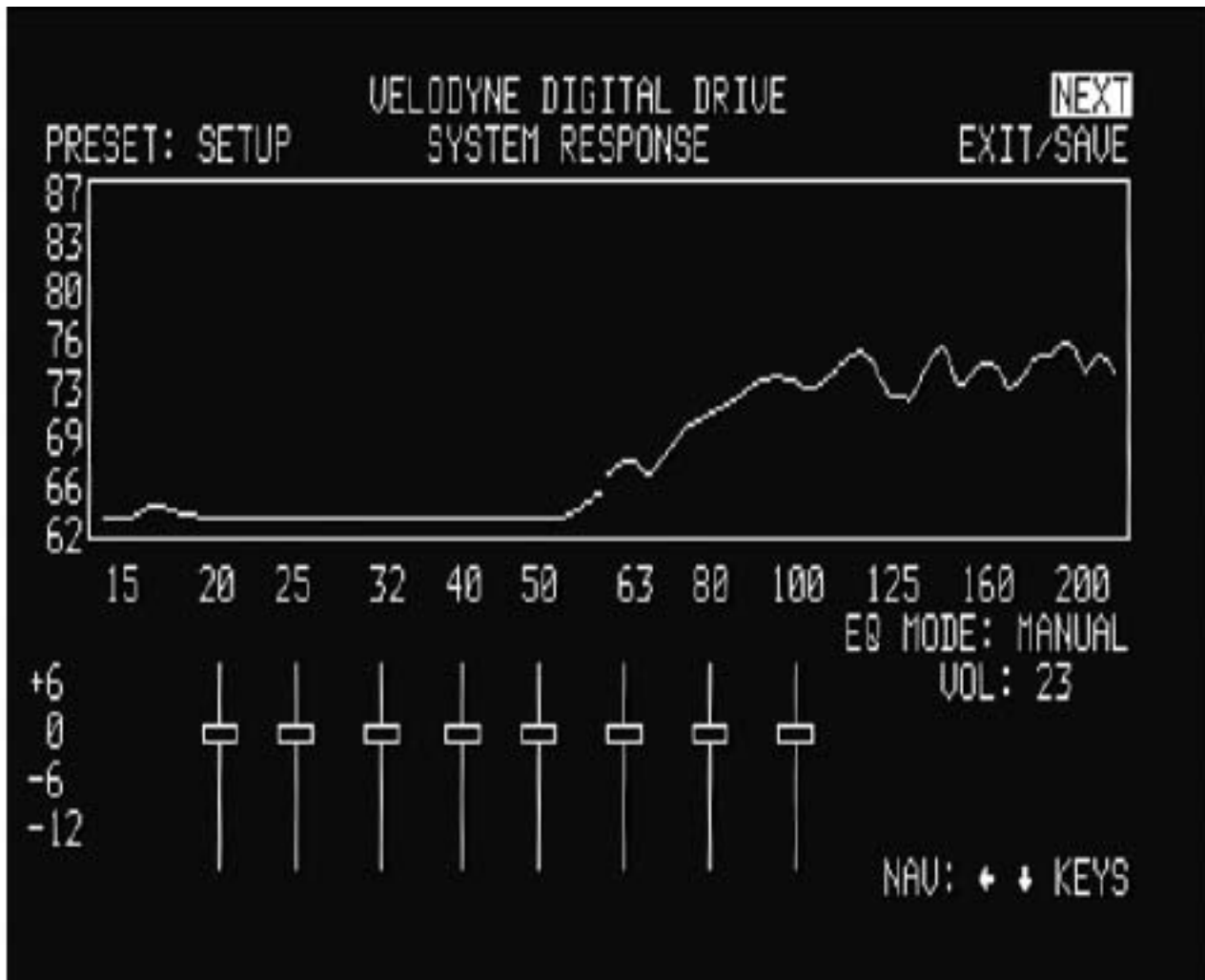

9. Now use the DD remote control to unmute the SMS-1, then use the volume up and down keys to match the level of the SMS-1 to your full range speakers. That is, the "SYSTEM RESPONSE" graph should be relatively flat (although at this point there will be peaks and valleys that will be addressed next).

NOTE: You may also need to adjust the volume of your subwoofer to achieve a good match. Make sure that the SMS-1's volume is not too low – it may require experimentation to find the proper balance between SMS-1 volume and your subwoofer's volume.

The screen should now look something like this:

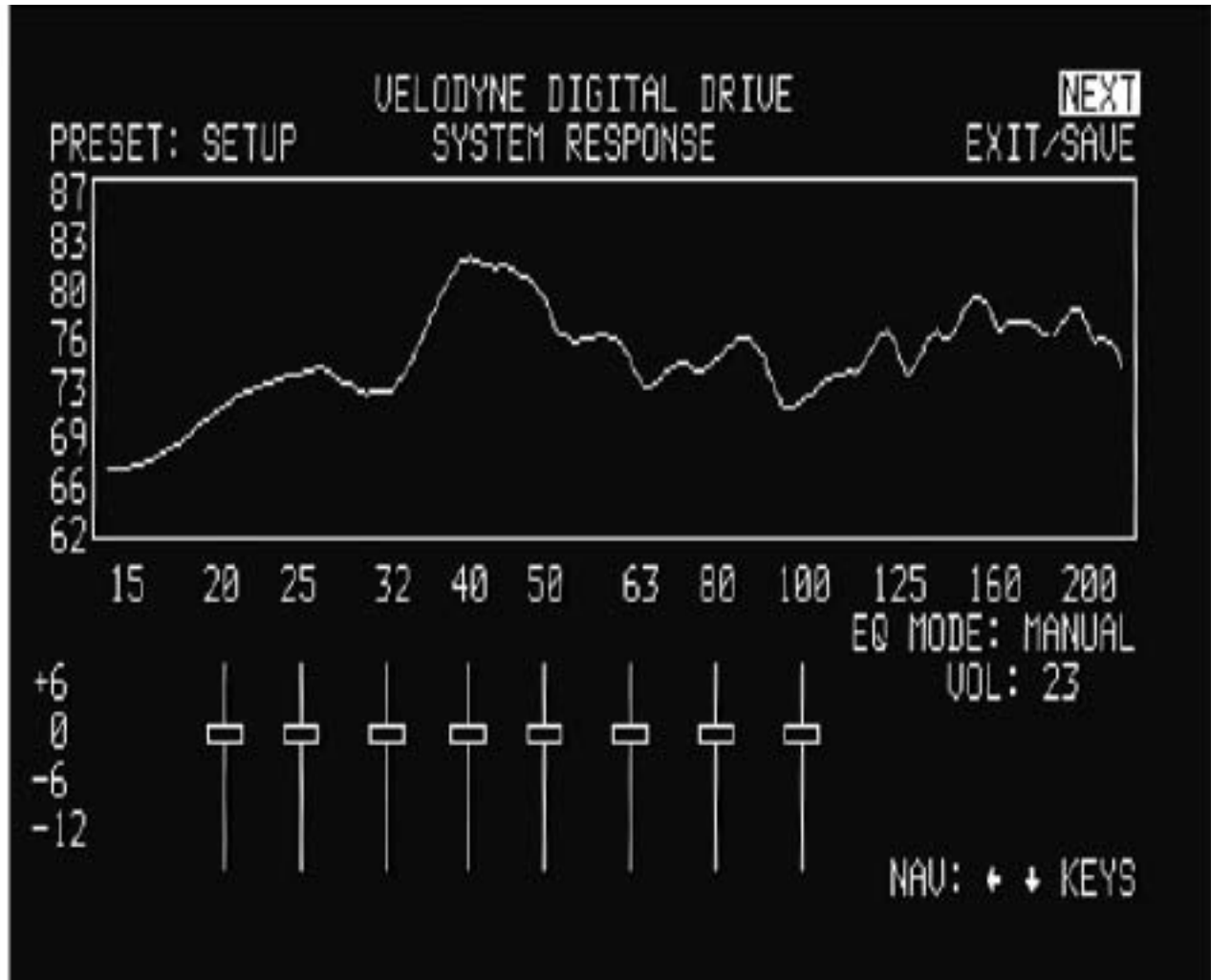

About Room Placement

Room placement is the first step in equalizing your subwoofer(s) to your main speakers and your room. Subwoofers operate at extremely low frequencies, which are primarily omni-directional (that is, you can't usually tell where they are coming from). Placing the subwoofer(s) in the room is a trial and-error process which is greatly aided by the SMS-1. The goal is to find the best location(s) that result in the minimum number and severity of valleys in the frequency response curve. This is because peaks in the response curve are easy to address with an EQ, but valleys typically are not easily fixed because they represent a cancellation of frequencies that more power to that frequency will usually not fix.

As a general rule, placing the sub(s) in the corner(s) of a room will add to the overall amount of bass the subwoofer produces, but that bass may not necessarily be as low in distortion compared to a position away from the corner. The worst location for a subwoofer is typically far away from any walls, and close to the center of your room. Avoid these locations when possible. When using a pair of subwoofers in stereo, it is preferable to place each subwoofer by the satellite of the same channel. If moving your satellites is an option, they too can contribute to peaks and valleys and should be likewise placed through experimentation.

Now you can begin moving your subwoofer(s) around the room to find the best placement position. You need to find the best tradeoff between appearance and room response. Be sure the room is in the configuration that it will be in when you typically listen – e.g. doors closed, curtains open or closed, etc. As you move the SMS-1, refer to the "SYSTEM RESPONSE" graph to minimize peaks and especially valleys in the response curve. As an example, you might find a location that smoothes the graph as follows:

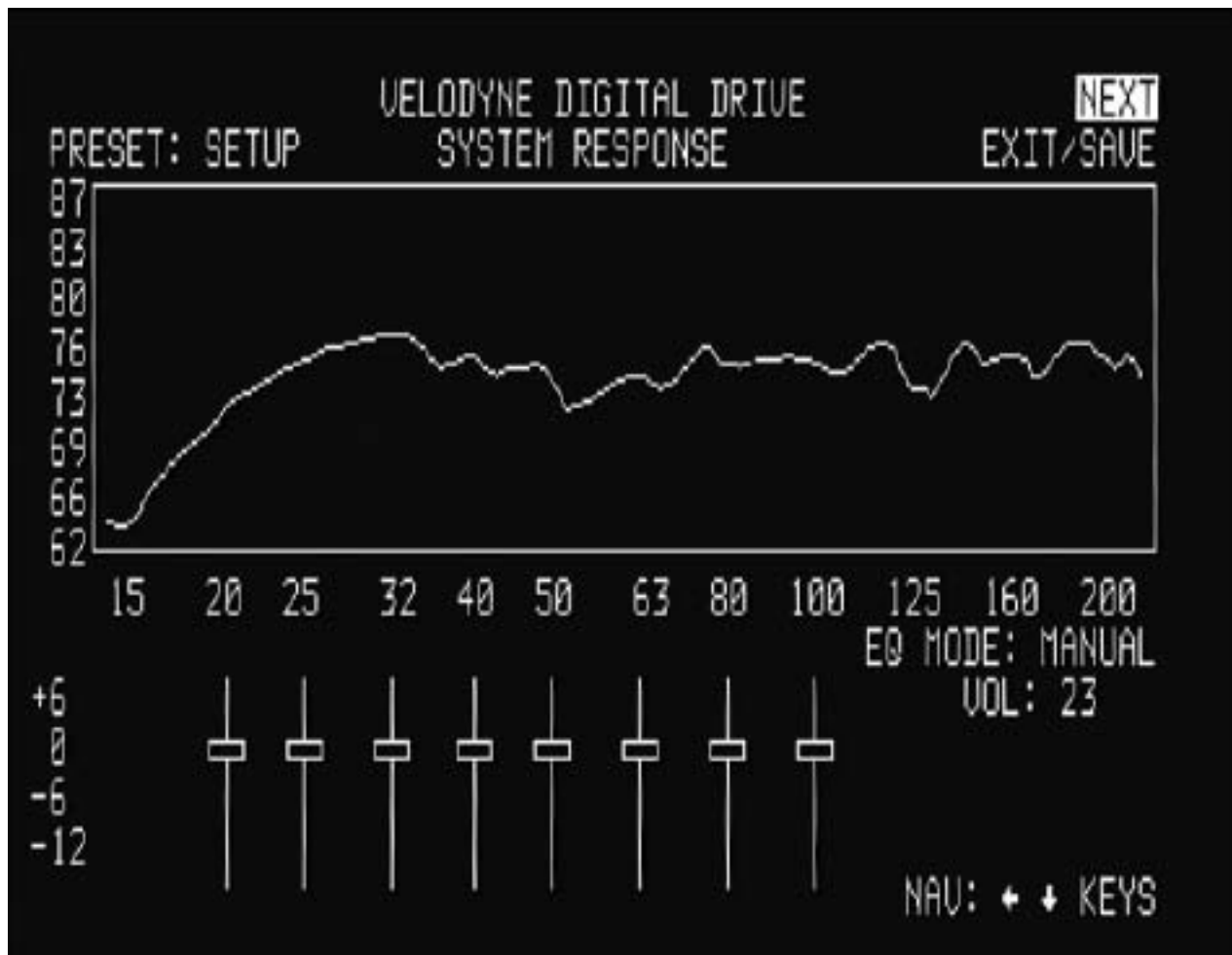

TIP: Here's an easy way to find the optimal position for your subwoofer without moving it to multiple positions in the room. Start by setting the subwoofer up in your listening position. Now, move the microphone around the room and observe the response graphs for different room positions. The best position has the fewest valleys and the overall smoothest response.

NOTE: If you are constrained in room location positions, don't worry! By following the setup steps below, Digital Drive bass management gives you lots of flexibility to make the most out of any subwoofer placement position.

11. Now that the room location has been chosen, turn off the SMS-1 and the rest of your system, permanently route the wiring, and reconnect to your SMS-1.
12. Reactivate the SMS-1 and your system and ensure that the system works as before.
13. Use the MENU button to get to the EQ setup screen (after entering the 12345 code), and then position the cursor over the NEXT field on the EQ setup screen. Press SELECT, and observe the SYSTEM SETTINGS screen, as follows:

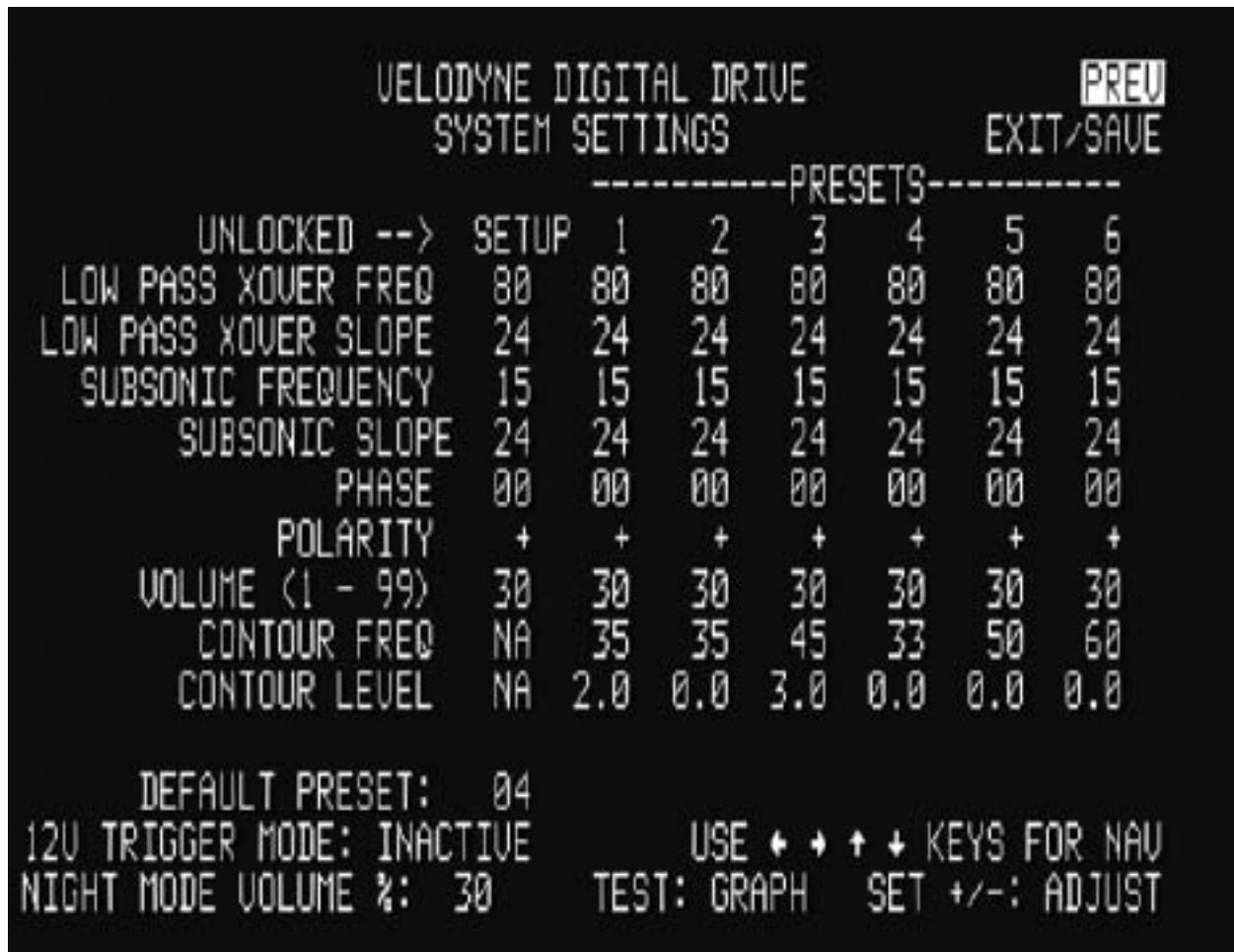

You are now ready to adjust the crossover, subsonic filter, volume, and phase controls of your SMS-1.

NOTE: if the remote seems intermittent or unresponsive, be sure you are pointing it at the SMS-1 and not your TV!

AND REMEMBER: Use the UP, DOWN, RIGHT and LEFT directional arrow buttons that surround SELECT to move through the fields of the setup screen, and change settings by using the SELECT button, then the UP and DOWN arrow keys. Or, you can skip the SELECT button and change values using the SET +/- buttons.

- When setting the low pass crossover, begin by setting the frequency and slope to the same values as the crossover settings on your receiver/processor (for example, many units have a large/small satellite setting). Again, consult your receiver/processor owner's manual for more information. You will notice that changing these values "cascades" the values out to all the presets. That is because once these values are set, they will not normally change from preset to preset, but if later you wish to customize a specific preset you can. An example of a crossover changed to 100 Hz is shown below:

VELODYNE DIGITAL DRIVE		PRESETS						PREV
SYSTEM SETTINGS								EXIT/SAVE
	SETUP	1	2	3	4	5	6	
UNLOCKED -->	100	100	100	100	100	100	100	
LOW PASS XOVER FREQ	100	100	100	100	100	100	100	
LOW PASS XOVER SLOPE	24	24	24	24	24	24	24	
SUBSONIC FREQUENCY	15	15	15	15	15	15	15	
SUBSONIC SLOPE	24	24	24	24	24	24	24	
PHASE	00	00	00	00	00	00	00	
POLARITY	+	+	+	+	+	+	+	
VOLUME <1 - 99>	30	30	30	30	30	30	30	
CONTOUR FREQ	NA	35	35	45	33	50	60	
CONTOUR LEVEL	NA	2.0	0.0	3.0	0.0	0.0	0.0	
DEFAULT PRESET: 04								
12V TRIGGER MODE: INACTIVE		USE + + ↑ ↓ KEYS FOR NAV						
NIGHT MODE VOLUME %: 30		TEST: GRAPH SET +/-: ADJUST						

TIP: To see immediate feedback on the effects of your changes to the "SYSTEM RESPONSE" graph, press the TEST button. The following screen appears:

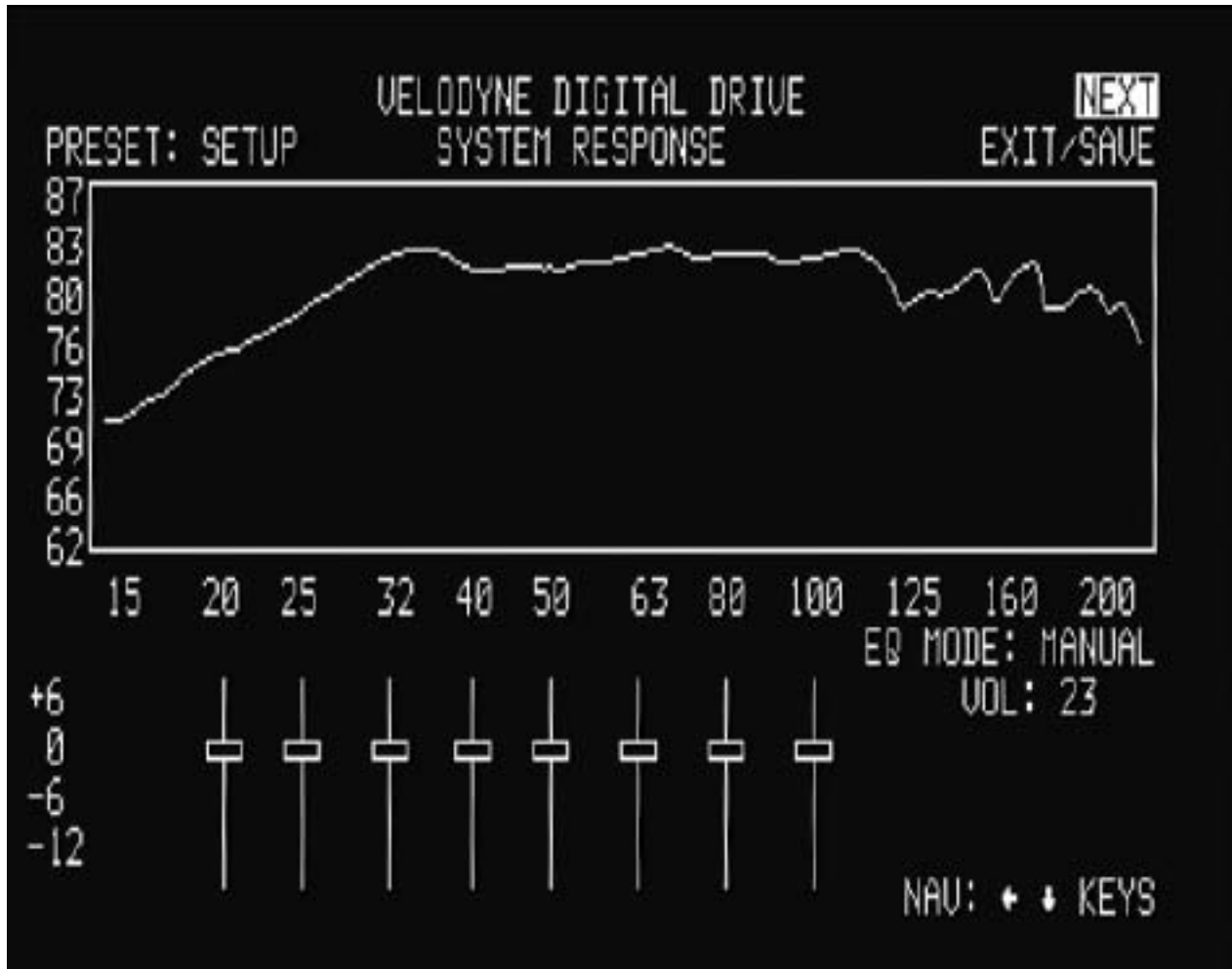

Press TEST again to return to the SYSTEM SETTINGS screen.

NOTE: Some receivers/processors supply a signal that is already crossed over – i.e. just the bass frequencies. If this is the case, you will want to defeat the SMS-1's low pass crossover. To defeat the low pass crossover, press the SELECT key, then the RESET key. OFF appears in all the low pass crossover and low pass slope fields.

NOTE: Your goal in setting the low pass crossover is to make the crossover point (the point at which the subwoofer meets the main speakers in terms of frequency) as smooth as possible. Another big factor in smoothing this point in the curve is phase, discussed in step 17, below.

15. Now adjust the low pass crossover slope. This setting is shipped at 24 dB/octave – a fairly steep slope to prevent the subwoofer from playing upper frequencies that might call attention to it during normal operation. At this stage, set the crossover settings under the column entitled SETUP. Reduce the slope if necessary and use the TEST button to return to the EQ setup screen and observe the "SYSTEM RESPONSE" graph – it should be as flat as possible at the crossover frequency and immediately to the left and right of it. Too gradual a slope (e.g. 6 dB/octave) may produce a bump at the crossover frequency, and too steep a slope may produce a dip.

16. You should normally not need to adjust the subsonic filter. Do so only if there are anomalies in the very lowest frequencies that you cannot address using the normal EQ process as described below.
17. Next adjust the phase and polarity settings. Phase is in effect a short delay in the reproduction of the audio signal. The polarity reverses the phase (i.e. 180° shift). Adjusting phase can change the dynamics of standing waves and frequency cancellations in the room. Sometimes it may be useful to adjust the phase if there is a particularly difficult peak or valley to eliminate, and/or your room placement options are limited. Phase and polarity are also important tools to match your subwoofer to your main speakers. You will often see a dip or peak in the crossover frequency between your subwoofer and main speakers. Rather than correcting this dip with an EQ, try adjusting the phase and polarity settings. It is very common for the main speakers to interact with the subwoofer to diminish or accent frequencies near the crossover point (since this is the point where both the subwoofer and the speakers are playing the same audio information). Don't be afraid to experiment to find the perfect match between your subwoofer and main speakers!

NOTE: The following step shows using the graphic equalizer (using fixed frequencies and Q) to equalize the room.

18. Next, return to the EQ setup screen and adjust the graphical EQs to eliminate peaks and valleys from the room response. Use the right and left arrow keys to position the cursor over the EQ you wish to adjust. If you see a peak in the response at, say, 25 Hz (this would be evident in the "SYSTEM RESPONSE" graph), simply navigate the cursor to the EQ that corresponds to 25Hz and use the up or down arrow keys to "slide" the EQ up or down. An example of this is shown below:

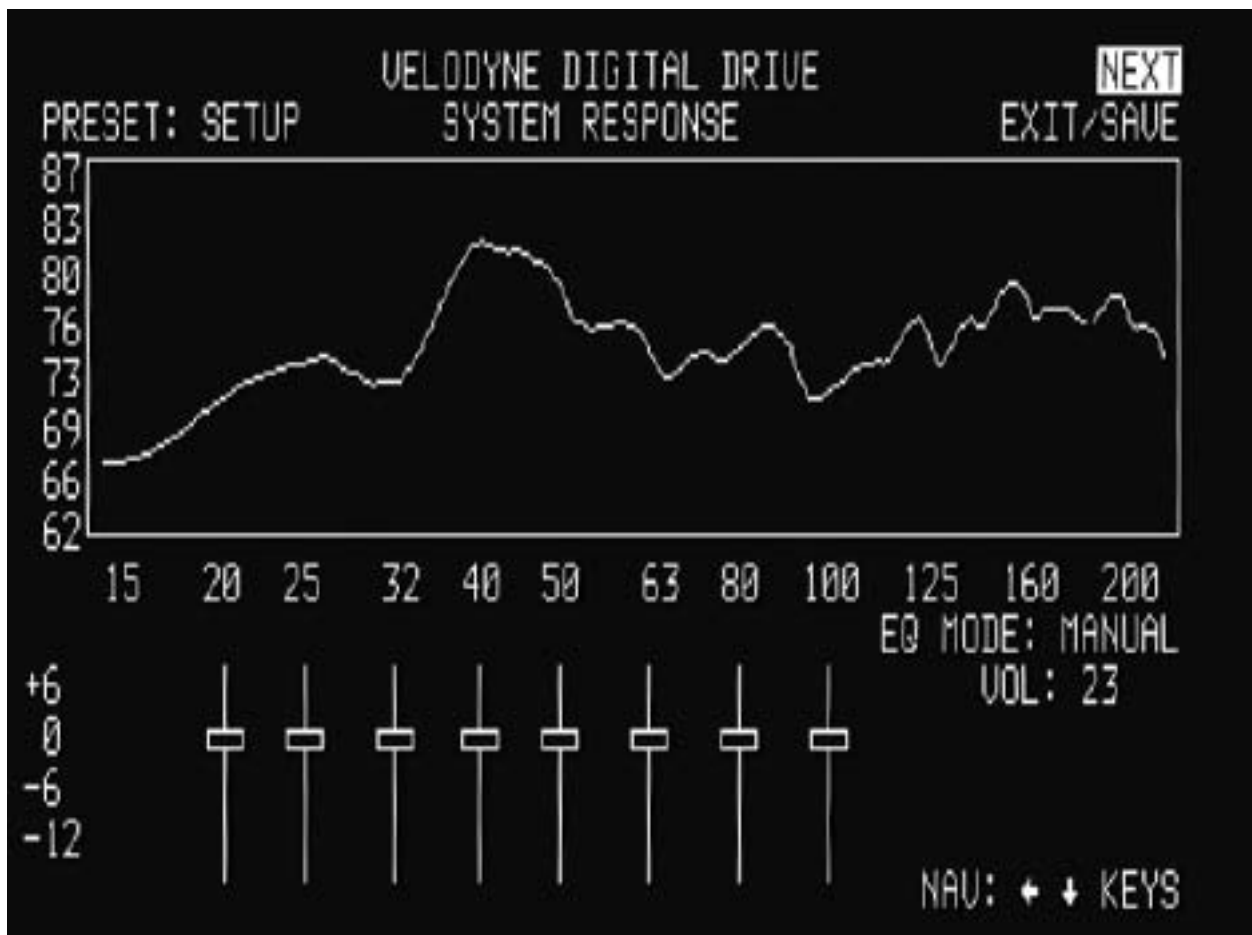

Continue this process until the "SYSTEM RESPONSE" graph shows a ± 3 dB response across the bass frequencies (that is, up to about 120 Hz.). Note that this does not necessarily mean a "ruler flat" response; ± 3 dB is typical for an optimized response curve.

An "equalized" room is shown below:

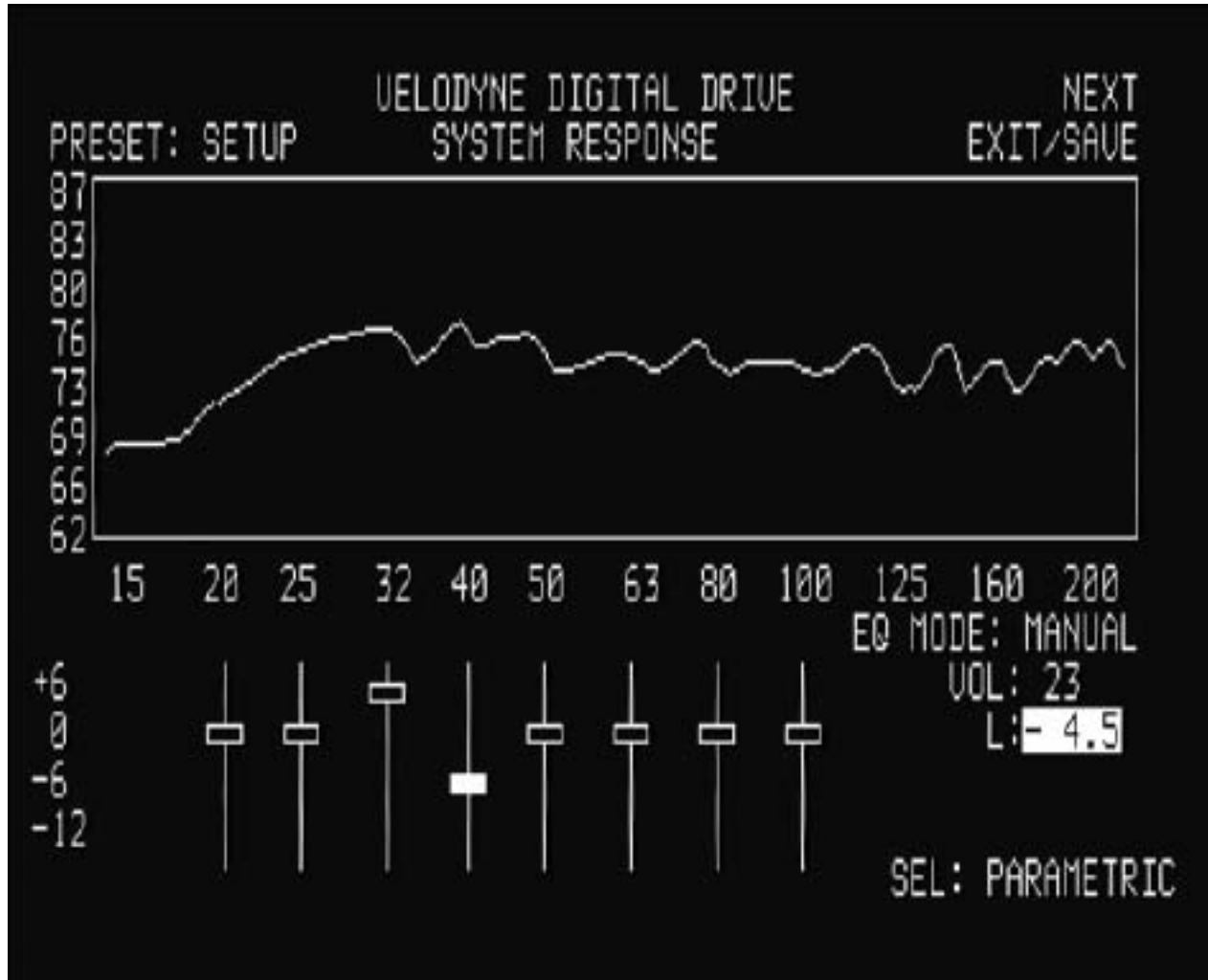

To have the unit EQ itself, select the auto EQ option, as shown:

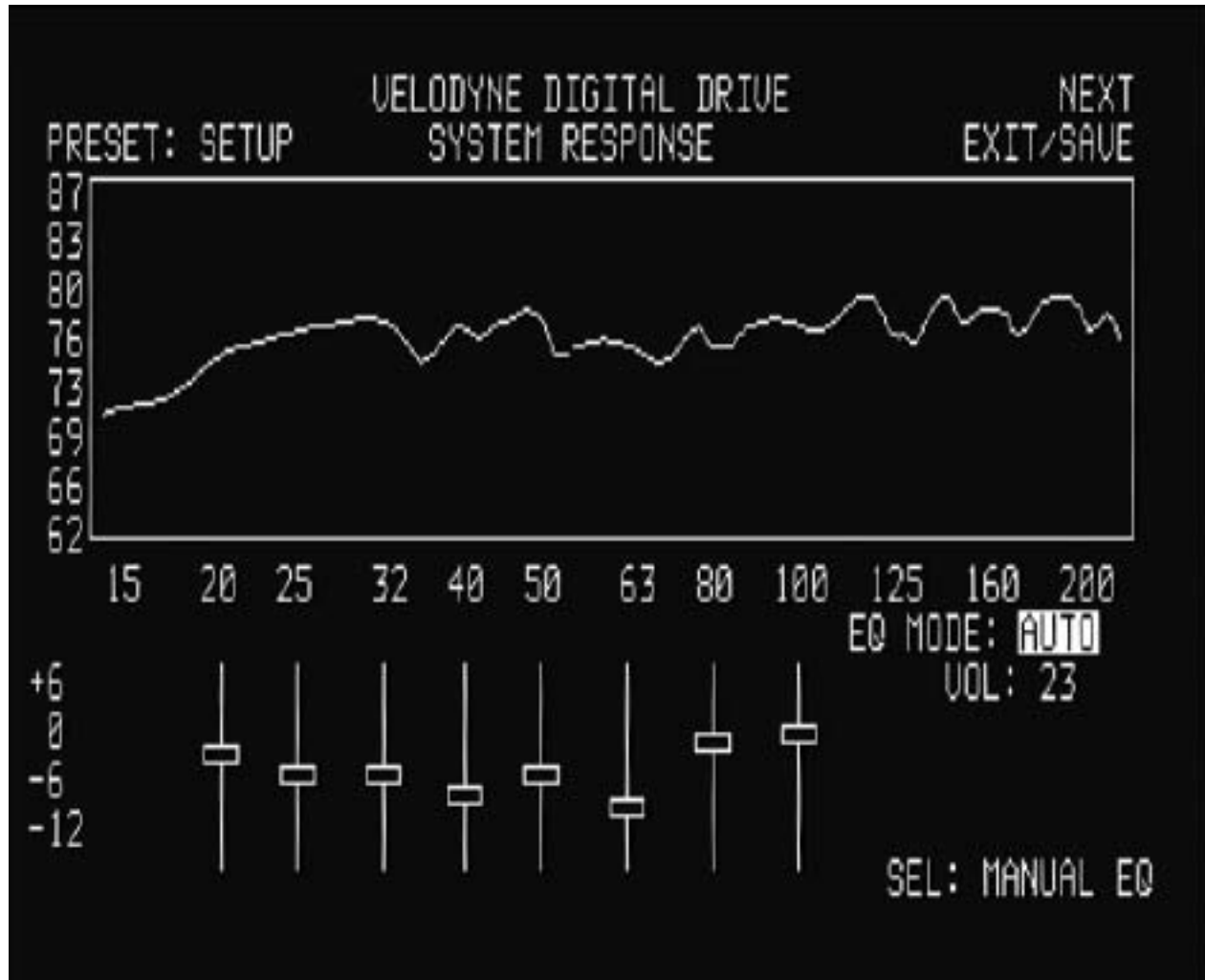

When this mode is selected, the unit automatically resets all EQs to their original frequencies, and Q settings (but retains any level changes you may have made). The AUTO EQ proceeds until you either save settings, press SELECT to return to manual EQ, move the cursor off the AUTO EQ field (in which case the field automatically reverts to MANUAL), or twenty five sweeps have occurred.

NOTE: The following steps use the parametric equalizer to achieve room equalization. If you do not wish to use the parametric EQ feature, skip to step 24.

21. To use the parametric EQ feature, position the cursor over the EQ and press the SELECT button. The values for that particular EQ appear on the right hand side of the screen. The following screen is shown:

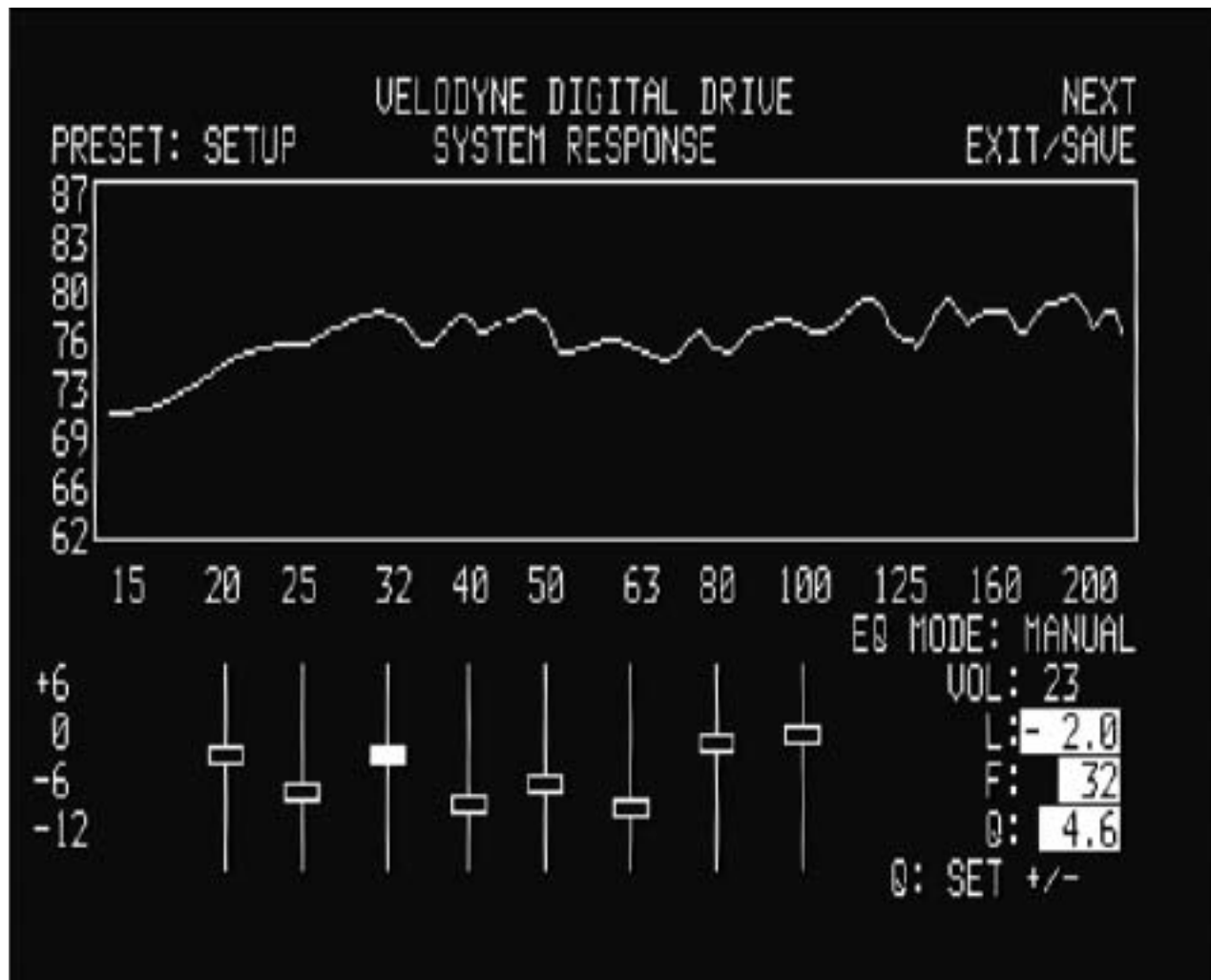

22. To manipulate a parametric EQ, you can now use the LEFT and RIGHT arrow keys to move the frequency up and down, and the SET + and SET - keys to change the Q value. Use the UP and DOWN arrow keys to adjust the level of the EQ as before. A selected EQ that has been moved, with its level raised and Q adjusted is shown below:

CAUTION: Using this feature could pose a danger to your subwoofer! It is possible to “stack” EQs - that is, setting them to identical or similar frequencies and boosting the signal at that frequency. Some users have configured their EQs to stack EQs at the lowest frequencies, such as 15 – 20 Hz, thus increasing the bass output of the subwoofer. The SMS-1 will deliver this signal directly to the subwoofer, and without adequate overdrive protection this could cause damage to the subwoofer even at normal playback levels.

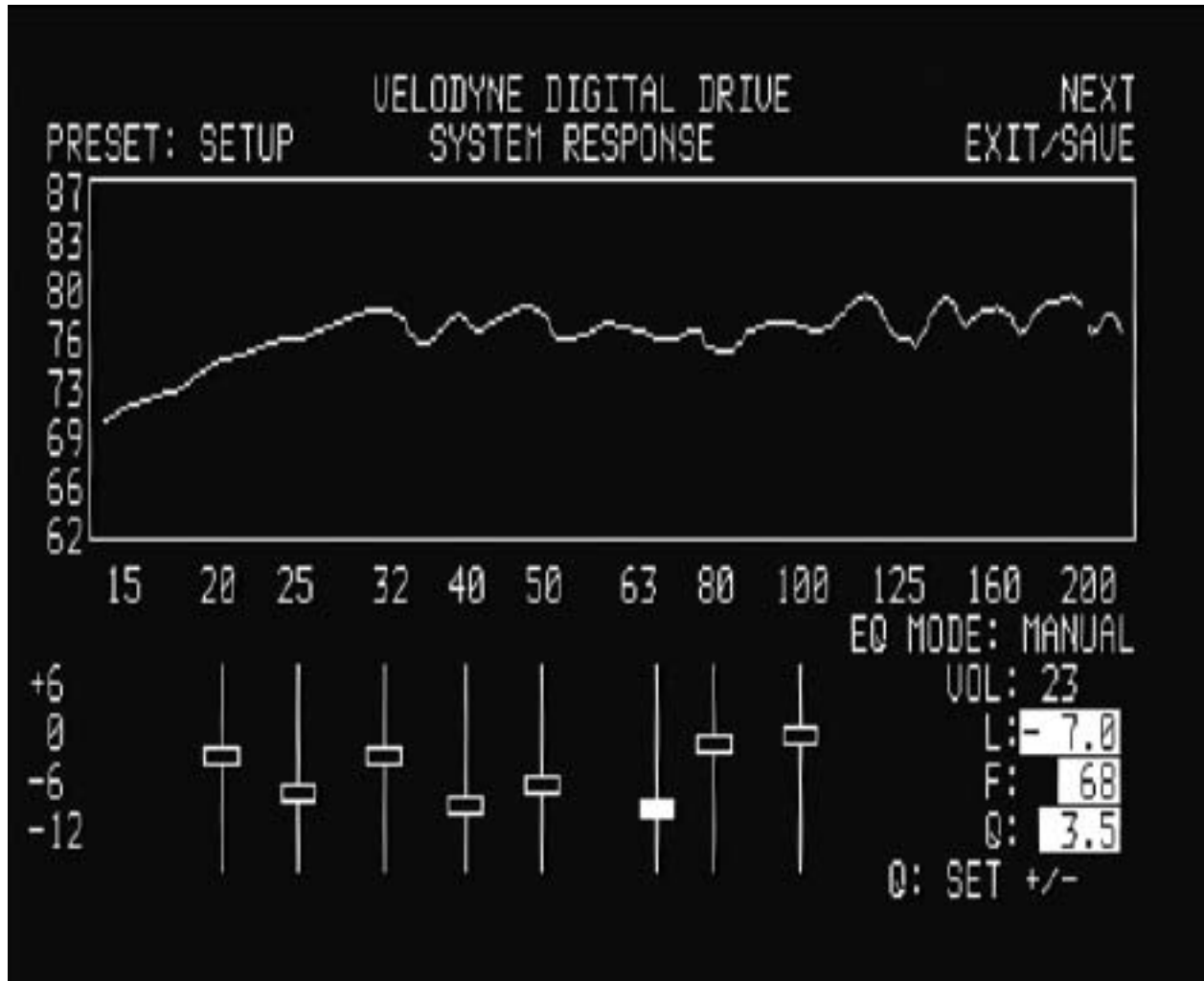

23. To unselect the EQ, press SELECT again, then use the right and left arrow keys to position the cursor on another EQ if desired, and repeat step 22, until the room is equalized.

24. Once the room has been equalized, you may want to return to the SYSTEM SETTINGS screen (by positioning the cursor over the NEXT field on the EQ setup screen and pressing SELECT) and review/modify the presets. This step is required ONLY if you wish to customize the presets. Before doing this, LOCK the Setup column by positioning the cursor over the LOCK screen and pressing SELECT.

You can change any value in the presets column, then use the TEST key to review the curve with these settings active. This is shown below.

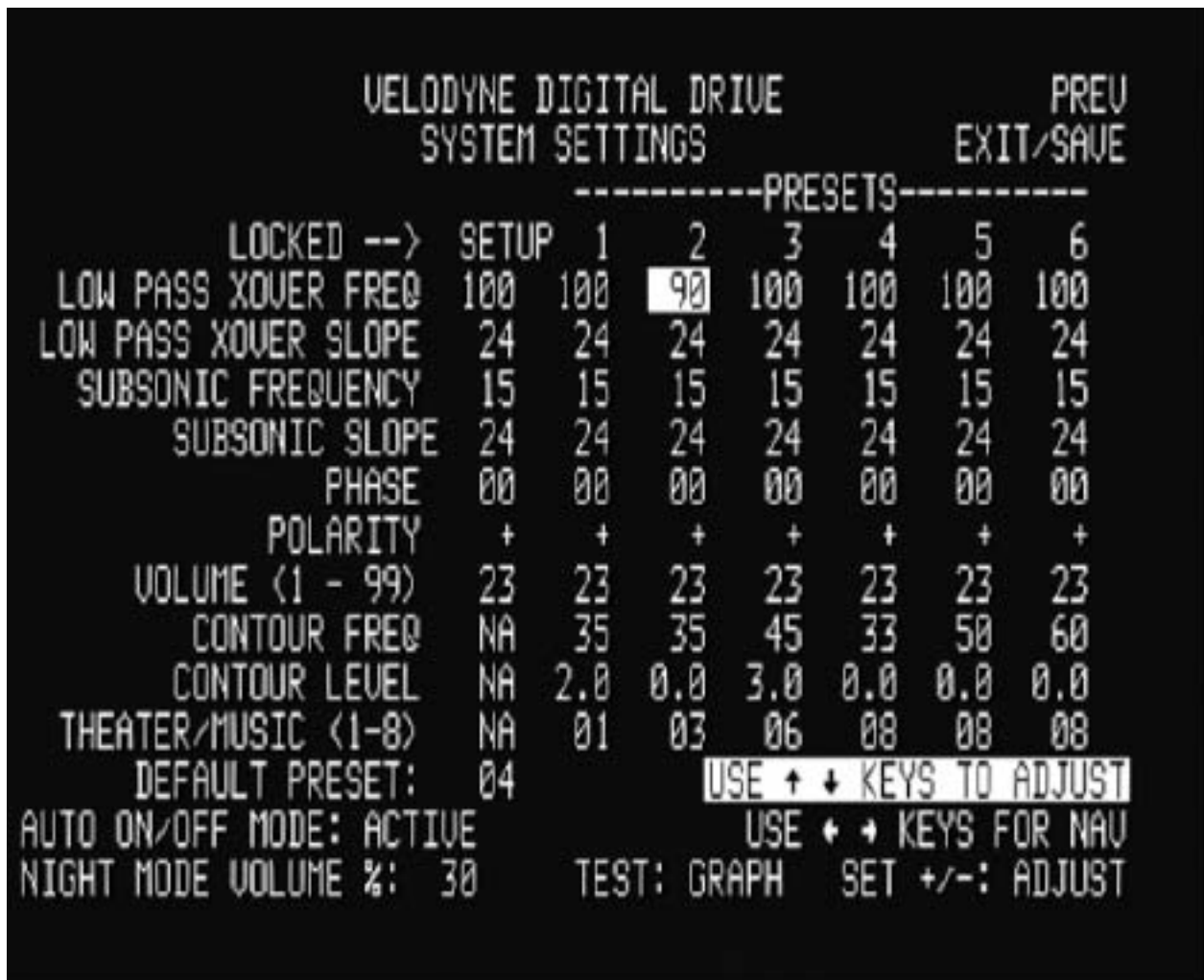

Features of each preset are:

EQ. There can be a completely different set of EQs for each preset. Simply select the preset you want on the “SYSTEM RESPONSE” screen where indicated.

Volume. This setting deviates the preset’s volume from the established system volume of the SMS-1. So, if you found during setup that 30 was a good setup volume for the SMS-1, then if you increased the volume for preset one to 40, the 40 volume would be invoked when preset one were selected for listening. If the system volume is changed (using the VOL + or VOL – keys on the remote), the preset volume is adjusted in lock step with the system volume.

Crossover, subsonic filter, phase and polarity settings. Normally these will not change from preset to preset. However, it may be that you are using different satellites for different listening modes and wish to set these settings individually for a specific preset. Note that the “setup” values cascade to the individual values for the presets, but you can change all the individual values if desired.

Contour frequency and level. These act as an “extra” EQ that can be used to manipulate the frequency contour of your SMS-1 when this particular preset is invoked. For example, notice that preset one raises the level by 3 dB at 35Hz – this is to accommodate action/adventure movie content.

EQ Curves. Each preset can have its own unique set of EQ settings. You can select which preset you want to EQ by either positioning the cursor on a preset column on the settings screen then pressing TEST, or by selecting the preset you want on the SYSTEM RESPONSE screen at the PRESET field, or by pressing one of the preset buttons on the remote.

You will note that presets 1-4 are shipped from the factory with predetermined settings, preset 5's contour is set at 0 level from the factory and customizable by the user (i.e. flat), and preset 6 defeats all the EQs to demonstrate the effect the equalization of the SMS-1 has on room response.

NOTE: you can select which preset is invoked at system startup by selecting it as shown:

VELODYNE DIGITAL DRIVE		SYSTEM SETTINGS						PREV EXIT/SAVE
		-----PRESETS-----						
UNLOCKED -->	SETUP	1	2	3	4	5	6	
LOW PASS XOVER FREQ	100	100	100	100	100	100	100	
LOW PASS XOVER SLOPE	24	24	24	24	24	24	24	
SUBSONIC FREQUENCY	15	15	15	15	15	15	15	
SUBSONIC SLOPE	24	24	24	24	24	24	24	
PHASE	00	00	00	00	00	00	00	
POLARITY	+	+	+	+	+	+	+	
VOLUME (1 - 99)	20	24	20	20	20	20	20	
CONTOUR FREQ	NA	35	35	45	33	50	60	
CONTOUR LEVEL	NA	2.0	0.0	3.0	0.0	0.0	0.0	

DEFAULT PRESET: **01**

12V TRIGGER MODE: INACTIVE USE ← → ↑ ↓ KEYS FOR NAV

NIGHT MODE VOLUME %: 30 TEST: GRAPH SET +/-: ADJUST

24. As a final thought on matching your subwoofer to your room, don't forget the "objective listening" test. That is, make sure the subwoofer sounds good to you! Often, you may want to add a bit more bass than what would normally be considered "flat" even after you remove the major peaks and valleys to achieve a flat frequency response. This is quite normal because human hearing "rolls off" rapidly below 100Hz, causing the bass not to sound as loud. This is the basis for the "loudness contour" switch included on many receivers and preamps. In order for the bass to sound flat, especially at lower levels, you may need to increase the SMS-1 volume in relation to the satellite speakers. An increase of about 5-8 dB is usually adequate. There are three methods to accomplish this:

1. Raise the internal volume control for the LFE out in your surround receiver or processor, or,

2. Raise the volume of the SMS-1 after you have finished your room equalization and other settings. You can observe this difference by watching the "SYSTEM RESPONSE" graph as you raise the volume, or,
3. Raise the volume on your subwoofer.

Of course, all hearing is different, so be sure to perform the above step "to taste."

25. Your setup is complete! You are now ready to save settings. You can press the EXIT button on the remote, or position the cursor over the SAVE/EXIT field on the screen and press select. The system responds with the following screen:

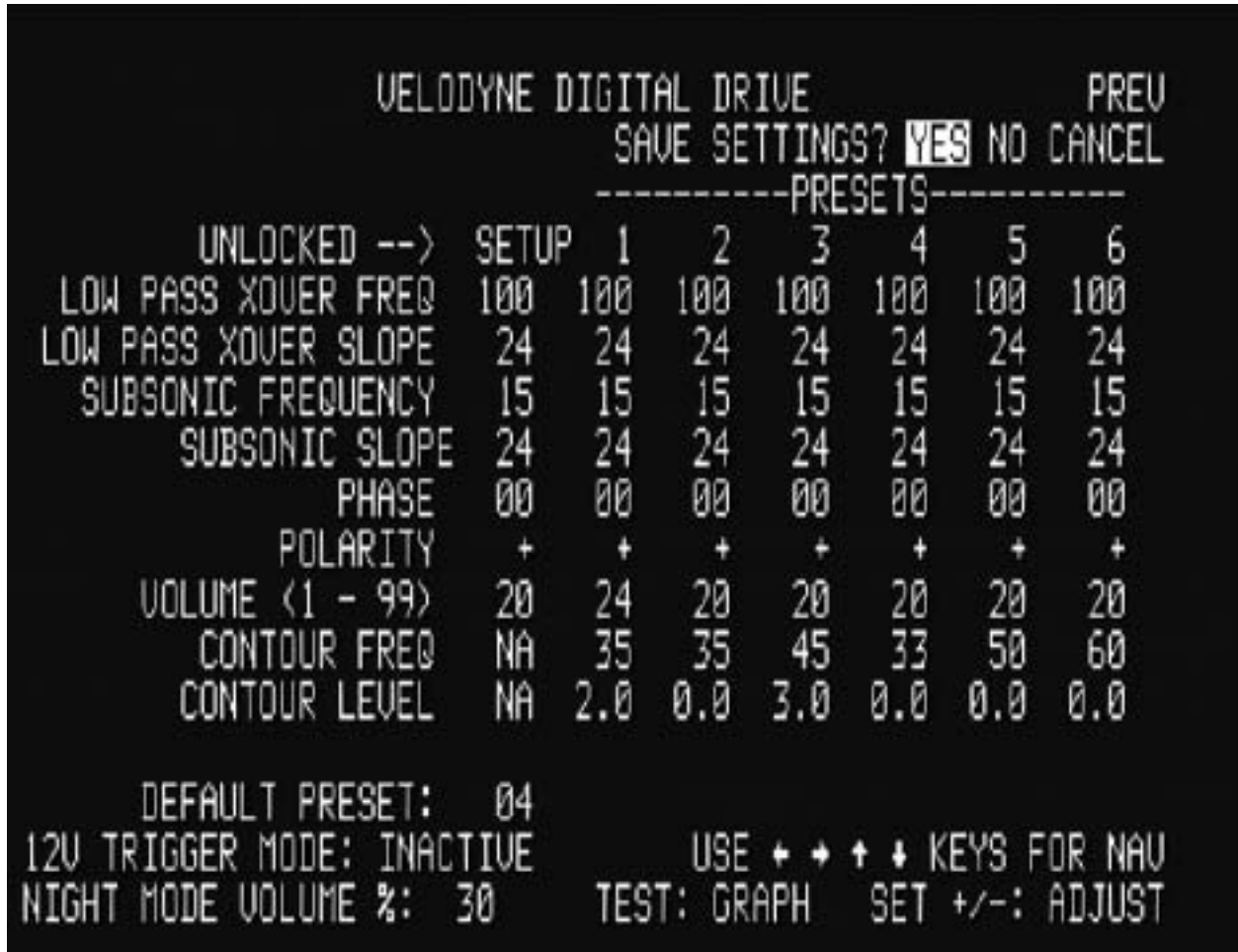

By pressing the SELECT button, you tell the system to save your settings and return to the introduction screen. Selecting NO returns without saving (i.e. whatever previous settings were in effect will be used), and CANCEL keeps you in setup mode.

When the unit saves settings, you will see the video flicker and you may hear a slight tick in your main speakers. This is normal behavior.

NOTE: The Digital Drive SMS-1 stores all of its settings in internal "Flash" memory. This memory persists even if the SMS-1 is turned off, loses power, or undergoes a programming update, so you need not worry about losing your customized settings.

RESTORING DEFAULTS

There is a feature in the SMS-1 that allows you to restore the factory defaults. On the main screen, simply press the 8, 9, and 0 buttons in sequence. After the sequence has been entered, the unit will flicker the video and then restore the main screen. The restoration of defaults is denoted on the main screen, as follows:

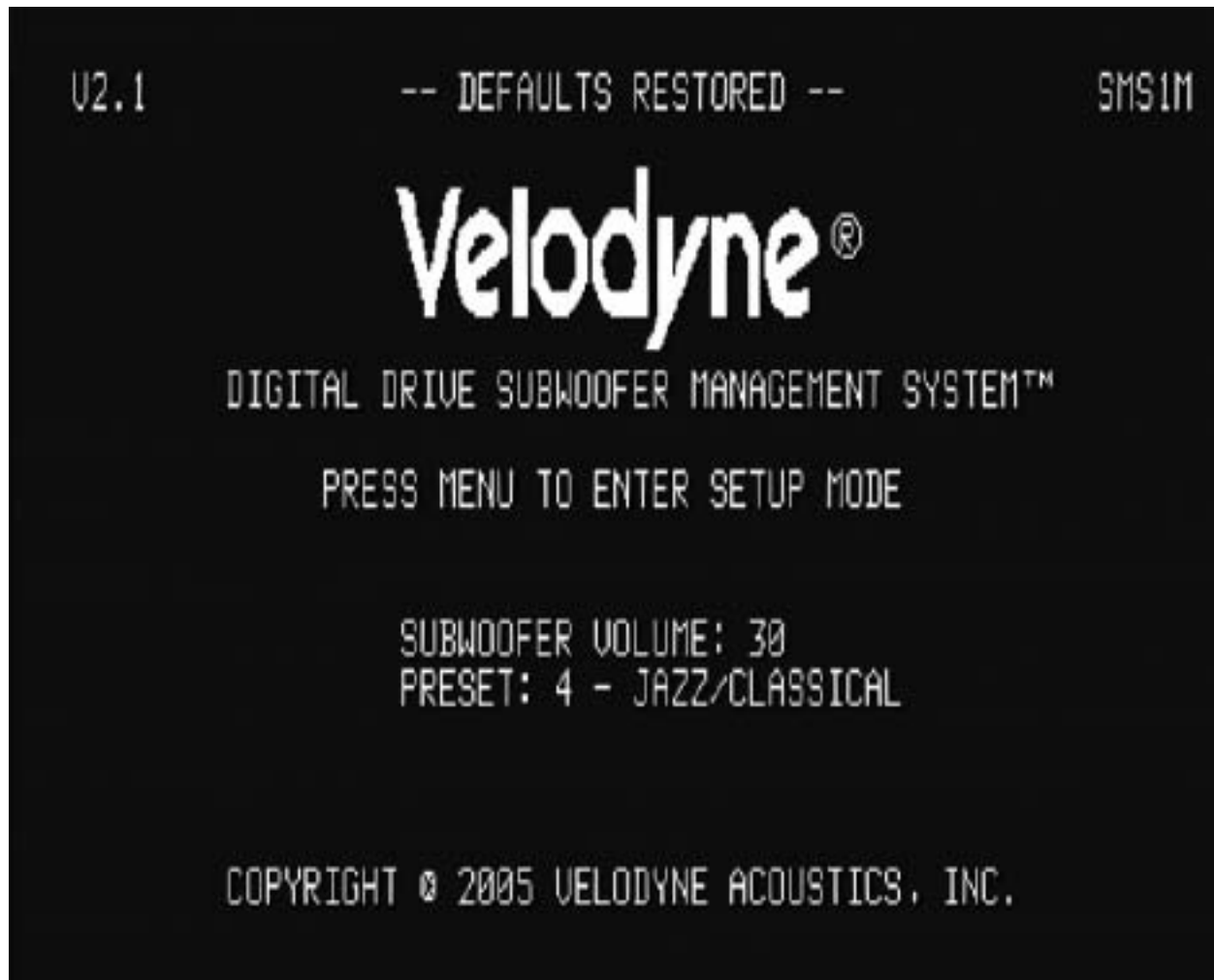

RUNTIME MODE

During normal use of your Digital Drive SMS-1, you can use the preset buttons to invoke certain presets, use the volume control to raise or lower the SMS-1's volume, use the light and night buttons to control the light and night mode, respectively, and use the mute button to mute the SMS-1. These settings are shown on the introductory screen, as follows:



NOTE: If you change the volume on your Digital Drive SMS-1 but later wish to return to the volume you established during setup (that is, as of your last save), press the RESET button.

12 VOLT TRIGGER MODE

The following screens show the use of the 12 volt trigger mode. The following screen denotes how to activate the 12 volt trigger feature:

VELODYNE DIGITAL DRIVE		SYSTEM SETTINGS						PREV
		-----PRESETS-----						EXIT/SAVE
UNLOCKED -->	SETUP	1	2	3	4	5	6	
LOW PASS XOVER FREQ	100	100	100	100	100	100	100	
LOW PASS XOVER SLOPE	24	24	24	24	24	24	24	
SUBSONIC FREQUENCY	15	15	15	15	15	15	15	
SUBSONIC SLOPE	24	24	24	24	24	24	24	
PHASE	00	00	00	00	00	00	00	
POLARITY	+	+	+	+	+	+	+	
VOLUME (1 - 99)	20	24	20	20	20	20	20	
CONTOUR FREQ	NA	35	35	45	33	50	60	
CONTOUR LEVEL	NA	2.0	0.0	3.0	0.0	0.0	0.0	
DEFAULT PRESET: 01								
12V TRIGGER MODE: ACTIVE		USE + + + + KEYS FOR NAV						
NIGHT MODE VOLUME %: 30		TEST: GRAPH SET +/-: ADJUST						

The following screen is shown when the unit is waiting for a 12 volt trigger to activate:

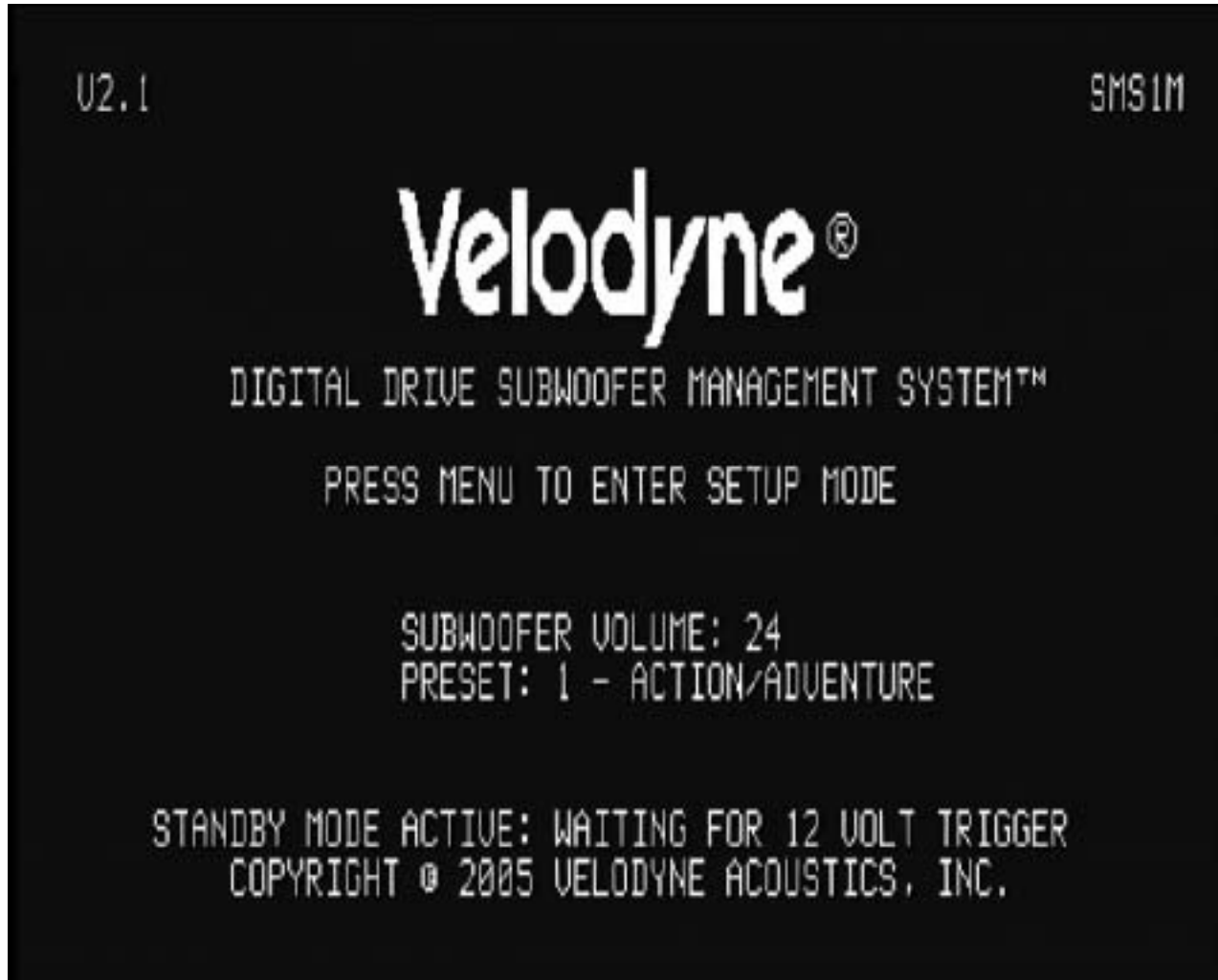

ABOUT ROOM EQUALIZATION

This section gives some background on room equalization. As a subwoofer plays in a room, the reflections of the sound waves off the walls create “standing waves,” that is, places in the room where certain frequencies are louder and others are diminished. In addition to standing waves, every room will also have locations where cancellations of the sound waves are like black holes that no amount of attenuation can fill. Thus as a general rule it is better to “cut down” a peak of response rather than to “boost up” a valley (i.e. possible black hole) of response.

In general, you are looking for a frequency response that is ± 3 dB at all frequencies (it is highly doubtful that your ears can tell a response that is any better than this). The response will always roll off at the low end (according to the settings of the subsonic filter), and there should be no dip or peak at the crossover frequency with the satellites. While the goal is perfectly flat response, this may not be possible in the higher frequencies of the subwoofer’s response due to peaks or valleys introduced by the satellites.

CARE OF YOUR DIGITAL DRIVE SMS-1

Do not use any harsh detergents or chemicals to clean the chassis. Abrasives, detergents, or cleaning solutions may damage the finish on the chassis. We recommend using a damp cloth to clean the chassis. During normal conditions, your new SMS-1 may be left on continuously without any problems. If you plan to leave the SMS-1 unused for an extended period of time, we recommend that you unplug the unit.

TROUBLESHOOTING AND SERVICE

If you should experience a problem with the operation of your SMS-1, please check all of the following before seeking service. Following is a simple troubleshooting guide to assist you.

1. Verify unit is plugged in and power outlet used is active.
2. Is the unit receiving an input signal from your source? A good way to test this is to connect the EQ audio out to the LFE input on the back panel, then enter setup mode (see Step 6). The woofer should play the sweep tone used for room EQ.
3. Have all controls on SMS-1 (volume, crossover, phase, etc.) been properly set?

The following conditions require service by a qualified technician:

1. The power supply or cord has become damaged.
2. The unit does not appear to operate normally or exhibits a marked change in performance.
3. The unit has been exposed to water.
4. Some part of the chassis or circuitry is physically damaged.

Software Updates

At the heart of Digital Drive functionality is the customized software. From time to time, Velodyne will publish updates to the Digital Drive software. To determine if your unit is a candidate for a software upgrade, observe the software version number in the upper left corner of the Main Screen (e.g. V2.1). Then visit www.velodyne.com and observe the version number of the software available for download. If this version is higher than the version in your unit, you may want to upgrade the software.

To upgrade the software, you will need an IBM-compatible PC with an available RS-232 9-pin serial port, and a male-to-female “Mouse Extension” serial cable. This cable is available from any computer store, your local Velodyne dealer, or directly from Velodyne. Next, proceed to the Velodyne web site and click on the link to download the software. Upon download, run the software and it will instruct you on completing the update process.

Thank you for purchasing a Velodyne!

APPENDIX A: RS-232 SERIAL OVERVIEW AND COMMANDS

Introduction

This document outlines Velodyne's Digital Drive (DD) RS-232 protocol specification. This protocol indicates how Digital Drive products receive run-time commands from devices such as Creston Universal Remote Controls.

Com Port Setup

Use standard communications settings: Baud Rate: 9600, Data Bits: 7, Parity: None, Stop Bits: 1

DD IN and OUT Port Pin Configuration

DD serial ports use a standard configuration that allows direct connection to a PC via a FEMALE to MALE serial cable. It uses only 3 pins (Transmit, Receive, Ground).

The pin configurations are:

IN: Pin 2 = Transmit
 Pin 3 = Receive
 Pin 5 = Ground

OUT: Pin 2 = Receive
 Pin 3 = Transmit
 Pin 5 = Ground

Runtime Command Format

Byte Number	Byte Description	Notes
0	'#'	Header Character
1 to 3 or 4	Command and Parameter Data	3 to 4 ASCII characters see formats below Case sensitive - CAPS ONLY!
4 or 5	'\$'	Termination Character (required or command is ignored)

RS232 Commands

Activity	Command Format	Acceptable n Values	Example(s)	Comments
Volume Control	#VOnn\$, #VO+,\$, #VO-\$, #VO?\$	00 – 99	#VO25\$, #VO+,\$, #VO-\$, #VO?\$	Sets volume to a value, increments volume up or down, or requests current volume setting
Preset Control	#PSn\$, #PS?\$	1, 2, 3, 4, 5, 6	#PS1\$, #PS2\$, #PS3\$, #PS4\$, #PS5\$, #PS6\$, #PS?\$	Activates the indicated preset, or requests the current preset
Logo Light Control	#LTn\$, #LT?\$	0: Light Off 1: Light On	#LTO\$ #LT1\$ #LT?\$	Turns the Logo Light on or off, or requests light state
Night Mode Control	#NMn\$, #NM?\$	0: Night Mode Off 1: Night Mode On	#NMO\$ #NM1\$ #NM?\$	Activates/Deactivates Night Mode, or requests light mode state
Mute Control	#MUn\$, #MU?\$ #MUO\$	0: Mute Off 1: Mute On	#MU1\$ #MU?\$	Mutes/Unmutes the woofer, or requests mute state
Power Control	#JUn\$, #JU?\$	0: Power Off 1: Power On	#JUO\$ #JU1\$ #JU?\$	Powers On/Powers Off the woofer, or requests power state

APPENDIX B: SUMMARY OF SPECIAL REMOTE CODES

Following are special remote codes and their functions. Unless otherwise noted, the codes are active only on the cover page.

Function	Code	Description
Self-EQ	3-2-1	Initiates Self-EQ feature. Be sure to connect the microphone before engaging. Press RESET to cancel prematurely. After 25 sweeps, the unit saves and resets.
Restore defaults	8-9-0	Restores defaults and resets the SMS-1.
Switch to PAL/SECAM video	DOWN ARROW 4 times followed by RESET	The unit restarts in PAL/SECAM video mode. TO restore NTSC mode, restore defaults.
Display serial number	UP ARROW 4 times then SELECT	Shows the serial number of the unit at the top of the screen.
Restore last saved volume	RESET	If volume is changed, restores last saved volume.

OTHER VELODYNE PRODUCTS:

Digital Drive Signature 1812™

HGS-X Series

HGS-10X
HGS-12X
HGS-15X

DLS-R Series

DLS-3500R
DLS-3750R
DLS-4000R
DLS-5000R

SPL-R Series

SPL-800R
SPL-1000R
SPL-1200R

VRP Series

VRP-1000
VRP-1200

DPS Series

DPS-10
DPS-12

VX Series

VX-10

LIMITED WARRANTY

VELODYNE ACOUSTICS, Inc. ("VELODYNE") warrants all powered subwoofers for a period of two years and full range speakers for a period of five years. All VELODYNE products have a warranty from the date of purchase against defects in materials and workmanship subject to the following conditions:

1. VELODYNE is not responsible for defects which result from the use of an amplifier or controller other than the one originally supplied with the unit (subwoofer) or defects which result from modifications or repairs made by any component of the system by anyone other than a VELODYNE factory authorized service representative.
2. This warranty is void if any repairs or service covered by the terms of this warranty are made to any component of the system by anyone other than a VELODYNE factory authorized service representative.
3. VELODYNE is not responsible for damage caused by accidents, abuse, misuse, natural or personal disaster or unauthorized modification. The VELODYNE products are not intended for professional or commercial use and VELODYNE is not responsible for damage resulting from such use.
4. The VELODYNE product warranty is limited to units that are purchased from authorized VELODYNE dealers and finalized within authorized dealer locations.
5. This warranty is nontransferable under any condition.

TO OBTAIN SERVICE

Information regarding service may be obtained from the dealer from whom you purchased the unit, or by contacting VELODYNE customer service. Warranty service must be performed by a VELODYNE factory authorized service representative within the warranty period set forth above. If VELODYNE determines the unit is defective, VELODYNE will, at VELODYNE's option, repair or replace the product at no charge if the product is forwarded prepaid to a factory authorized service representative. Products forwarded to the factory authorized service representative should be shipped securely and properly packaged, insured and freight prepaid.

"The technology and digital signal processing used on this product leaves all that have come before in the dark ages . . . The DD-18 is loud, deep, scary and above all, bloody lovely. It integrates so well into a home theatre system you'll be convinced you have a whole new set of speakers. . ."

Home Cinema Choice Magazine
- UK, November 2004

"... my strongest recommendation ... after using Velodyne's Digital Drive software, I don't understand how anyone will be able to go back to tuning a subwoofer by ear."

Stereophile Magazine
- U.S., June 2004

"Velodyne's DD-15 Digital Drive Subwoofer improves bass reproduction as much as the jet engine improved air travel."

Home Entertainment Magazine
- U.S., May/June 2004

". . . I was expecting big things from the DD-12 and boy, did it deliver. If you want tight, room-shaking bass that dives way down where your ears won't go but your guts know all about it, this is it."

Tone Magazine
- New Zealand, May/June 2004



Velodyne Acoustics, Inc.

345 Digital Drive
Morgan Hill, CA 95037

408.465.2800 voice
408.779.9227 fax
408.779.9208 service fax

www.velodyne.com
Service E-mail: service@velodyne.com
Product E-mail: help@velodyne.com
Technical E-mail: techhelp@velodyne.com



63-SMS1 RevD 22AUG05